

# PM<sup>®</sup> CONA<sup>®</sup>

PROTECTING YOUR FUTURE, LIGHTING YOUR LIFE.

**55**  
Years of  
Reliability



DOWNLOAD  
CATALOGUE SWITCHES  
& ACCESSORIES



DOWNLOAD  
LED, MCB & WIRES  
CATALOGUE



SCAN FOR  
POWERMAN  
POLICY



APRIL 2026 | PRODUCT PRICE LIST

**55**  
**YEARS OF**  
**RELIABILITY**



**Dr. Prakash Motwani** has worked tirelessly since over 4 decades to develop this wide range of products of international level quality while maintaining intact the fundamental principals of safety, value and innovation. He is the recipient of several national and international awards for his outstanding contribution to the field of manufacturing industry.



## COMPANY PROFILE

PM CONA is the country's answer to across-the-board Electrical Switches and Wiring Accessories. Since its inception in 1968, the brand name has always been synonymous with great quality, wide product range, innovative products, flawless safety, long durability, and affordable prices. We have registered ourselves as one of the leading manufacturers, exporters and suppliers of electrical products that are highly demanded all over the world. We have come a long way since our inception with the support of a highly professional team and world class infrastructure.

## THE BRAND

PM CONA has a nationwide presence and has been growing consistently, driven by strong values of safety, continuous innovation and value. With manufacturing units at Mumbai, Vasai, Palghar, Delhi, Silvassa & Haridwar, and 7 fully working Laboratories, we continue to grow with presence all across INDIA.

## MISSION

We Strive To Provide Highest Quality Of Electrical Products Which Are



Safe



Durable



Affordable



Innovative



Convenient



Consistent



# C O N T E N T

- 01 Skylight LED
- 51 Assure MCB
- 61 TripRite MCB
- 67 Trisafe+ Wires
- 73 Eco FR Wires

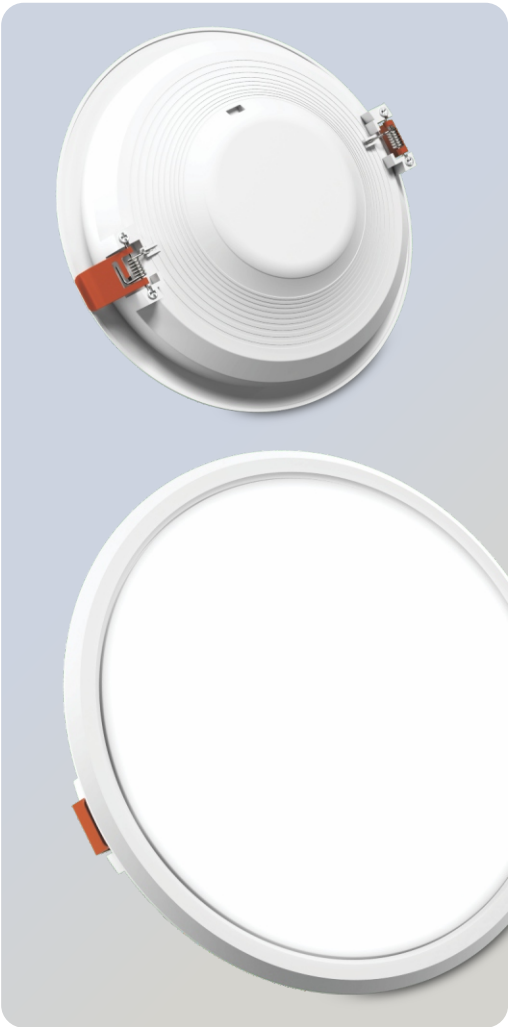

# MODERN PANEL LIGHT

Upgrade your lighting with our LED Panel Lights sleek, energy-efficient, and designed for modern spaces. These panels provide uniform, glare-free illumination, creating a bright, inviting atmosphere in any room. Perfect for both residential and commercial settings, our LED Panel Lights combine style with functionality, delivering exceptional brightness and reducing energy costs.



# APPLICATIONS

 RESIDENTIALS	 HOTELS	 SHOPS
 HOSPITALS	 RESTAURANTS	 SHOPPING COMPLEXES



# SLIM

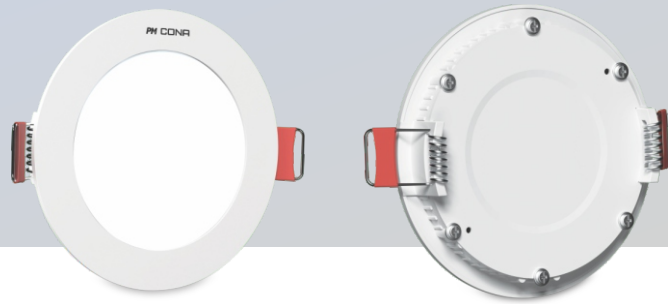

○ COOL LIGHT   ● WARM LIGHT   ● NATURAL LIGHT

SLIM PANEL - ROUND		AC 220V - 240V		120°	BEAM ANGLE	80	CRI	
CODE	WATT	RATE PER Pc. ₹	CUTOUT SIZE	OUTER DIMENSIONS	LUMENS*	PF	MINI PKG.	BULK PKG.
16006	6W	295/-	ϕ 105 mm	Ø 120 x 22 mm	450	>0.5	50	100
16012	12W	415/-	ϕ 160 mm	Ø 171 x 22 mm	960	>0.5	50	100
16018	18W	645/-	ϕ 185 mm	Ø 198 x 23 mm	1440	>0.5	-	40

SLIM PANEL - SQUARE		AC 220V - 240V		120°	BEAM ANGLE	80	CRI	
CODE	WATT	RATE PER Pc. ₹	CUTOUT SIZE	OUTER DIMENSIONS	LUMENS*	PF	MINI PKG.	BULK PKG.
16106	6W	295/-	ϕ 105 x 105 mm	Ø 122 x 122 x 22 mm	450	>0.5	50	100
16112	12W	415/-	ϕ 160 x 160 mm	Ø 173 x 173 x 22 mm	960	>0.5	50	100
16118	18W	645/-	ϕ 185 x 185 mm	Ø 198 x 198 x 23 mm	1440	>0.5	-	40

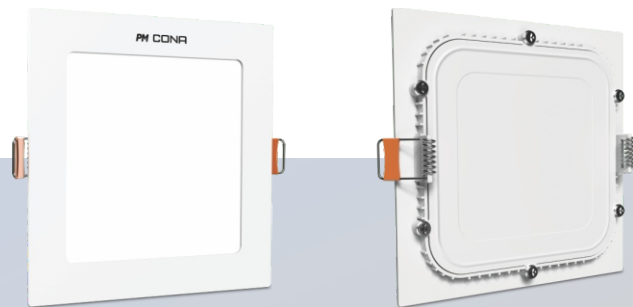

# SPECTRUM

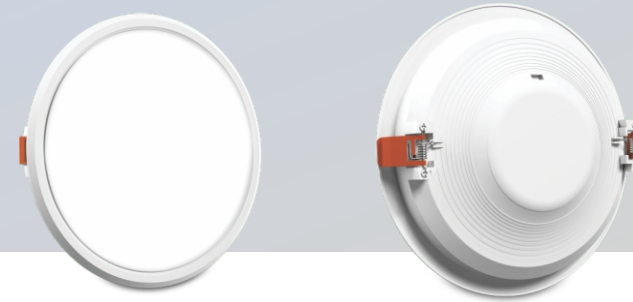

○ COOL LIGHT   ● WARM LIGHT   ● NATURAL LIGHT

DOWNLIGHT PANEL - ROUND		AC 220V - 240V		120°	BEAM ANGLE	80	CRI	
CODE	WATT	RATE PER Pc. ₹	CUTOUT SIZE	OUTER DIMENSIONS	LUMENS*	PF	MINI PKG.	BULK PKG.
16008	8W	245/-	ϕ 105 mm	Ø 115 x 35 mm	600	>0.9	50	100
16016	16W	375/-	ϕ 130 mm	Ø 144 x 35 mm	1280	>0.9	50	100
<b>ON ORDER</b> 16022	<b>22W</b>	<b>495/-</b>	<b>ϕ 153 mm</b>	<b>Ø 166 x 35 mm</b>	<b>1760</b>	<b>&gt;0.9</b>	<b>50</b>	<b>100</b>

DOWNLIGHT PANEL - SQUARE		AC 220V - 240V		120°	BEAM ANGLE	80	CRI	
CODE	WATT	RATE PER Pc. ₹	CUTOUT SIZE	OUTER DIMENSIONS	LUMENS*	PF	MINI PKG.	BULK PKG.
16108	8W	245/-	ϕ 105 x 105 mm	Ø 115 x 115 x 35 mm	600	>0.9	50	100
16116	16W	375/-	ϕ 130 x 130 mm	Ø 144 x 144 x 35 mm	1280	>0.9	50	100
<b>ON ORDER</b> 16122	<b>22W</b>	<b>495/-</b>	<b>ϕ 153 x 153 mm</b>	<b>Ø 166 x 166 x 35 mm</b>	<b>1760</b>	<b>&gt;0.9</b>	<b>50</b>	<b>100</b>

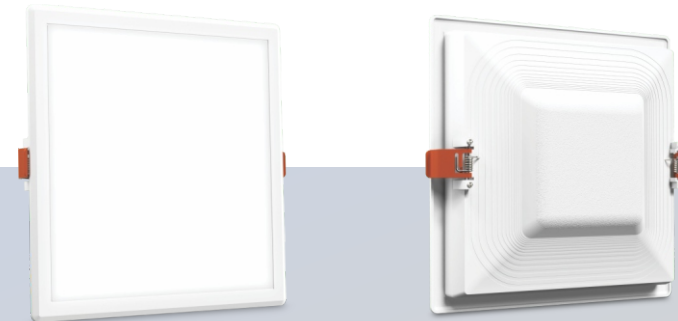

**ON ORDER** Note: Availability of green highlighted products is on order basis.



**NEW**

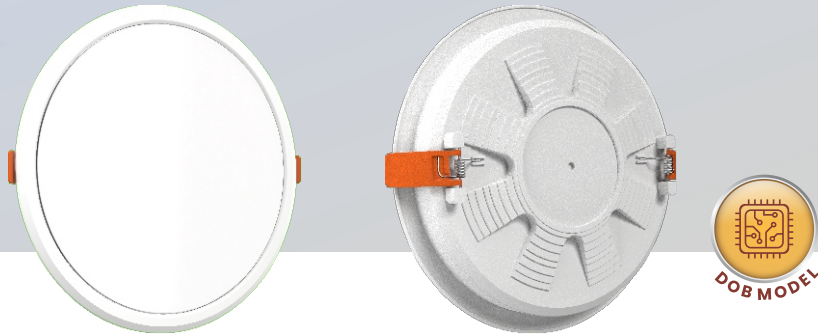

○ COOL LIGHT ● WARM LIGHT ● NATURAL LIGHT

**DOB DOWNLIGHT PANEL - ROUND** AC 220V - 240V **120°** BEAM ANGLE **80** CRI

CODE	WATT	RATE PER Pc. ₹	CUTOUT SIZE	OUTER DIMENSIONS	LUMENS*	PF	MINI PKG.	BULK PKG.
17008	<b>8W</b>	<b>235/-</b>	ϕ 95 mm	Ø 118 x 29 mm	600	>0.9	50	100
17016	<b>16W</b>	<b>355/-</b>	ϕ 145 mm	Ø 167 x 30 mm	1125	>0.9	50	100

**DOB DOWNLIGHT PANEL - SQUARE** AC 220V - 240V **120°** BEAM ANGLE **80** CRI

CODE	WATT	RATE PER Pc. ₹	CUTOUT SIZE	OUTER DIMENSIONS	LUMENS*	PF	MINI PKG.	BULK PKG.
17228	<b>8W</b>	<b>235/-</b>	ϕ 95 x 95 mm	Ø 108 x 118 x 29 mm	600	>0.9	50	100
17226	<b>16W</b>	<b>355/-</b>	ϕ 145 x 145 mm	Ø 159 x 167 x 30 mm	1125	>0.9	50	100

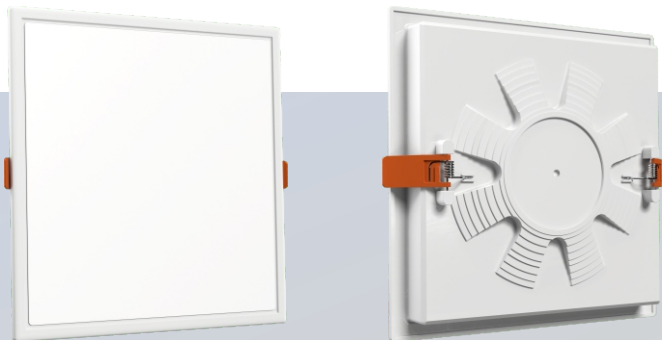

- LONG DISTANCE ILLUMINATION
- HIGH BRIGHTNESS
- SURGE PROTECTION
- ZERO MAINTENANCE

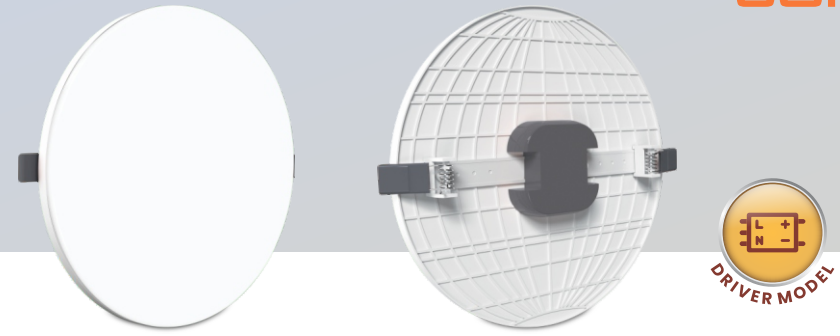

○ COOL LIGHT ● WARM LIGHT ● NATURAL LIGHT

**ADJUSTABLE PANEL - ROUND** AC 220V - 240V **110°** BEAM ANGLE **80** CRI

CODE	WATT	RATE PER Pc. ₹	CUTOUT SIZE	OUTER DIMENSIONS	LUMENS*	PF	MINI PKG.	BULK PKG.
17312	<b>12W</b>	<b>545/-</b>	ϕ 75-100 mm	Ø 120 x 32 mm	960	>0.9	40	80
17318	<b>18W</b>	<b>755/-</b>	ϕ 75-150 mm	Ø 170 x 32 mm	1440	>0.9	20	60
17324	<b>24W</b>	<b>1075/-</b>	ϕ 75-200 mm	Ø 223 x 32 mm	1920	>0.9	20	40

**ADJUSTABLE PANEL - SQUARE** AC 220V - 240V **110°** BEAM ANGLE **80** CRI

CODE	WATT	RATE PER Pc. ₹	CUTOUT SIZE	OUTER DIMENSIONS	LUMENS*	PF	MINI PKG.	BULK PKG.
17412	<b>12W</b>	<b>535/-</b>	ϕ 75-100 mm	Ø 120 x 120 X 32 mm	960	>0.9	40	80
17418	<b>18W</b>	<b>755/-</b>	ϕ 75-150 mm	Ø 170 x 170 x 32 mm	1440	>0.9	20	60
17424	<b>24W</b>	<b>1075/-</b>	ϕ 75-200 mm	Ø 223 x 223 x 32 mm	1920	>0.9	20	40



- EASY FIT
- LONG DISTANCE ILLUMINATION
- HIGH BRIGHTNESS
- SURGE PROTECTION
- ZERO MAINTENANCE

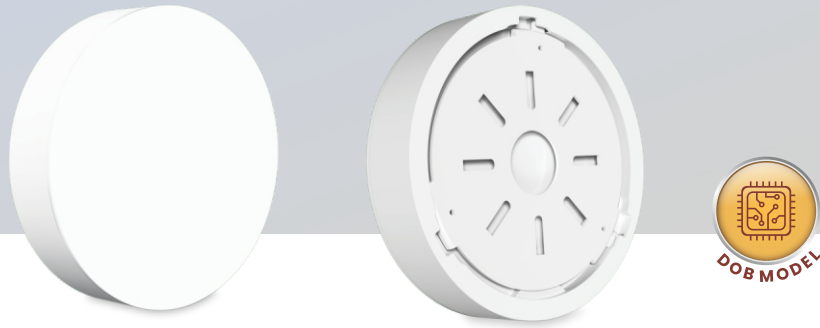

○ COOL LIGHT ● WARM LIGHT ● NATURAL LIGHT

**FRAMELESS SURFACE PANEL - ROUND** AC 220V - 240V **120°** BEAM ANGLE **80** CRI

CODE	WATT	RATE PER PC. ₹	CUTOUT SIZE	OUTER DIMENSIONS	LUMENS*	PF	MINI PKG.	BULK PKG.
17006	<b>6W</b>	<b>285/-</b>	-	Ø 95 x 31 mm	480	>0.9	40	120
17012	<b>12W</b>	<b>425/-</b>	-	Ø 123 x 31 mm	960	>0.9	40	80
17018	<b>18W</b>	<b>655/-</b>	-	Ø 158 x 31 mm	1440	>0.9	40	80

**FRAMELESS SURFACE PANEL - SQUARE** AC 220V - 240V **120°** BEAM ANGLE **80** CRI

CODE	WATT	RATE PER PC. ₹	CUTOUT SIZE	OUTER DIMENSIONS	LUMENS*	PF	MINI PKG.	BULK PKG.
17106	<b>6W</b>	<b>285/-</b>	-	Ø 95 x 95 x 31 mm	480	>0.9	40	120
17112	<b>12W</b>	<b>425/-</b>	-	Ø 123 x 123 x 31 mm	960	>0.9	40	80
17118	<b>18W</b>	<b>655/-</b>	-	Ø 158 x 158 x 31 mm	1440	>0.9	40	80



- LONG DISTANCE ILLUMINATION
- HIGH BRIGHTNESS
- SURGE PROTECTION
- ZERO MAINTENANCE

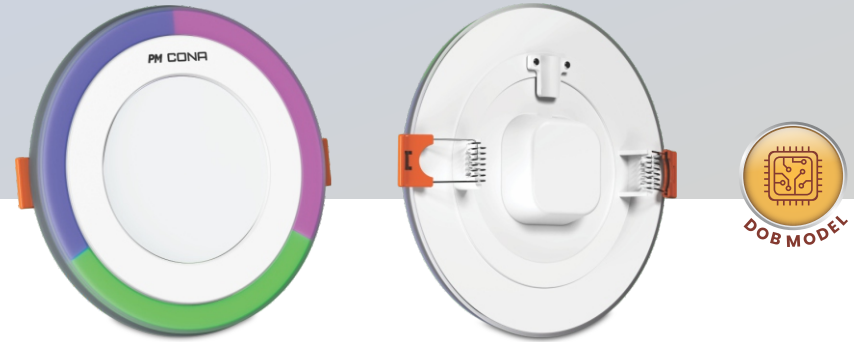

**DOUBLE COLOUR PANEL PC BODY** AC 220V - 240V **120°** BEAM ANGLE **80** CRI

CODE	WATT	RATE PER PC. ₹	CUTOUT SIZE	OUTER DIMENSIONS	LUMENS*	PF	MINI PKG.	BULK PKG.
17603	<b>3+3W</b> Round Panel	<b>275/-</b>	ϕ 90 mm	Ø 105 x 23 mm	225	>0.9	50	200
17606	<b>6+3W</b> Round Panel	<b>415/-</b>	ϕ 125 mm	Ø 145 x 23 mm	450	>0.9	30	90
17607	<b>6+3W</b> Surface Round Panel	<b>465/-</b>	-	Ø 147 x 34 mm	450	>0.9	30	90
17616	<b>6+3W</b> Square Panel	<b>415/-</b>	ϕ 125 mm	Ø 145 x 23 mm	450	>0.9	30	90
17627	<b>6+3W</b> Surface Square Panel	<b>465/-</b>	-	Ø 147 x 34 mm	450	>0.9	30	90

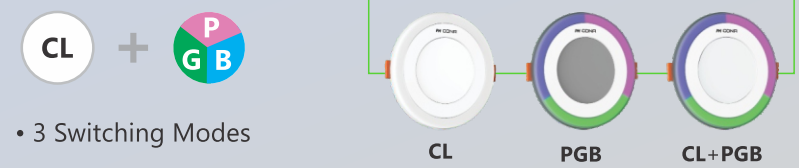

• 3 Switching Modes

- LONG DISTANCE ILLUMINATION
- HIGH BRIGHTNESS
- SURGE PROTECTION
- ZERO MAINTENANCE

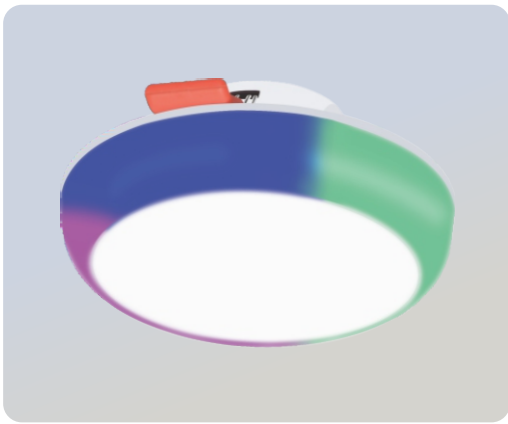

# MODERN CONCEALED LIGHTS



Discover the elegance of our Concealed Lights subtle yet powerful, they blend seamlessly into your space, offering soft, ambient lighting that enhances your room's aesthetics while providing efficient, shadow-free illumination.

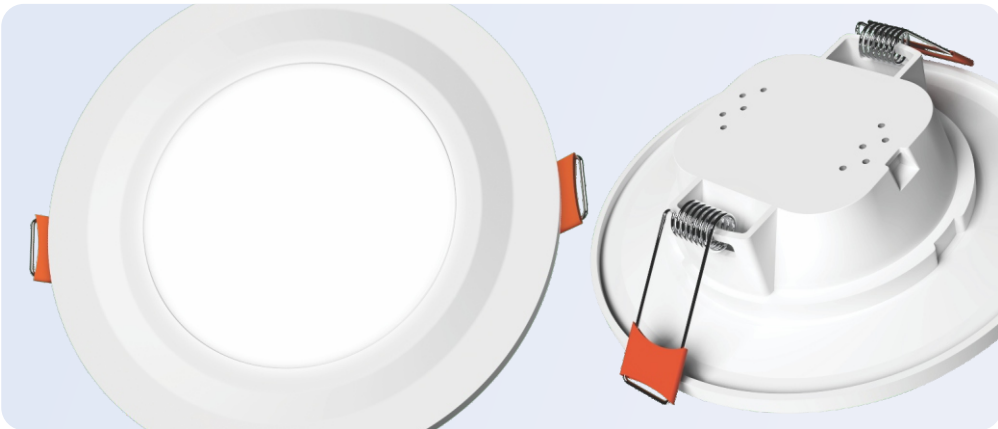

# APPLICATIONS

 CABINETS	 RESIDENTIAL	 SHOWROOMS
 SHELF SPACE	 MALLS	 SCHOOL & COLLEGES

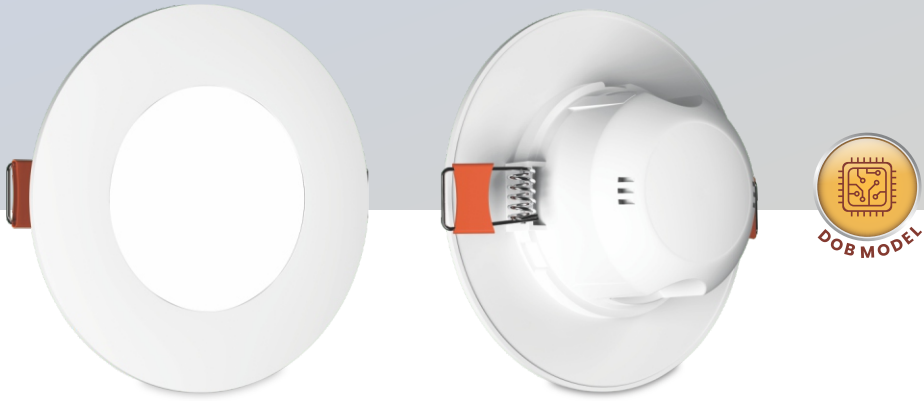

○ COOL LIGHT   ● WARM LIGHT   ● RED   ● GREEN   ● BLUE   ● PINK

CONCEALED LIGHT		AC 220V - 240V		120°	BEAM ANGLE	80	CRI	
CODE	WATT	RATE PER Pc. ₹	CUTOUT SIZE	OUTER DIMENSIONS	LUMENS*	PF	MINI PKG.	BULK PKG.
16203	3W	155/-	ϕ 60 mm	Ø 81 x 34 mm	225	>0.9	100	300
16205	5W	195/-	ϕ 70 mm	Ø 108 x 26 mm	375	>0.9	100	400

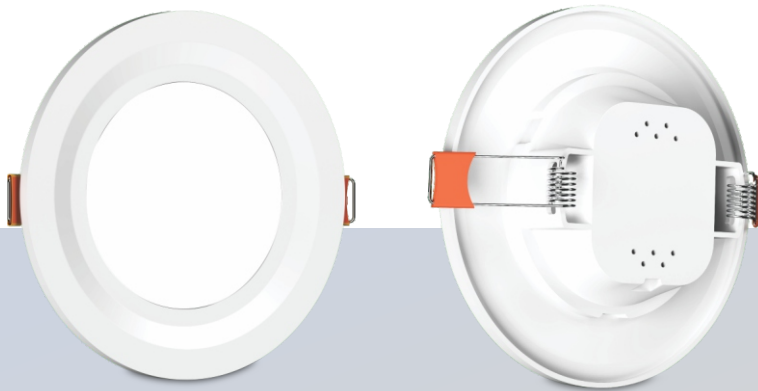

- LONG DISTANCE ILLUMINATION
- HIGH BRIGHTNESS
- SURGE PROTECTION
- ZERO MAINTENANCE



○ COOL LIGHT   ● WARM LIGHT   ● RED   ● GREEN   ● BLUE   ● PINK

CONCEALED LIGHT		AC 220V - 240V		120°	BEAM ANGLE	80	CRI	
CODE	WATT	RATE PER Pc. ₹	CUTOUT SIZE	OUTER DIMENSIONS	LUMENS*	PF	MINI PKG.	BULK PKG.
<b>ON ORDER</b> 17206	6W	225/-	ϕ 80 mm	Ø 111 x 30 mm	420	>0.9	100	200
16307	7W	245/-	ϕ 80 mm	Ø 114 x 48 mm	525	>0.9	100	200

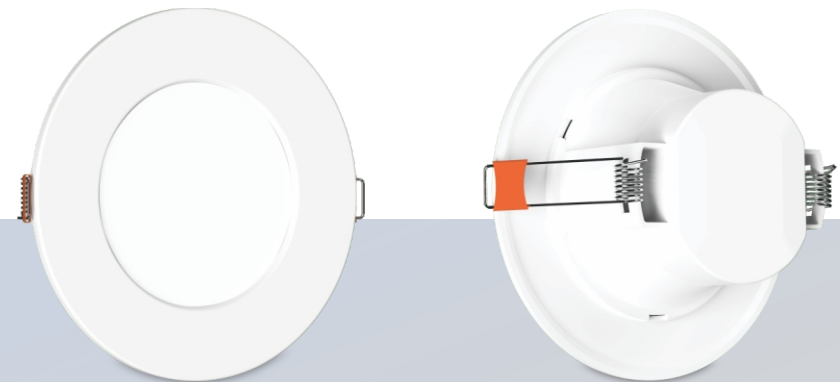

**ON ORDER** Note: Availability of green highlighted products is on order basis.

- LONG DISTANCE ILLUMINATION
- HIGH BRIGHTNESS
- SURGE PROTECTION
- ZERO MAINTENANCE



○ COOL LIGHT   ● WARM LIGHT   ● RED   ● GREEN   ● BLUE   ● PINK

CONCEALED LIGHT		AC 220V - 240V		120° BEAM ANGLE	80 CRI			
CODE	WATT	RATE PER Pc. ₹	CUTOUT SIZE	OUTER DIMENSIONS	LUMENS*	PF	MINI PKG.	BULK PKG.
NEW 17409	9W	255/-	ϕ 70 mm	Ø 125 x 28 mm	900	>0.9	50	100

○ COOL LIGHT   ● WARM LIGHT   ● NATURAL LIGHT

CONCEALED LIGHT		AC 220V - 240V		120° BEAM ANGLE	80 CRI			
CODE	WATT	RATE PER Pc. ₹	CUTOUT SIZE	OUTER DIMENSIONS	LUMENS*	PF	MINI PKG.	BULK PKG.
17522	12W	345/-	ϕ 103 mm	Ø 130 x 28 mm	900	>0.9	50	100

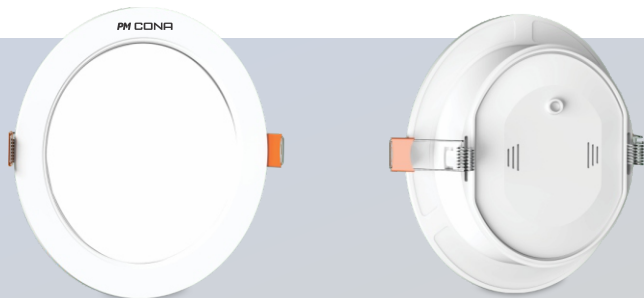

- LONG DISTANCE ILLUMINATION
- HIGH BRIGHTNESS
- SURGE PROTECTION
- ZERO MAINTENANCE

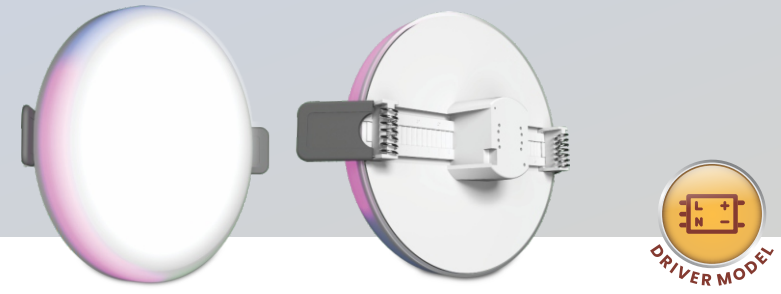

DOUBLE COLOUR CONCEALED LIGHT		AC 220V - 240V		120° BEAM ANGLE	80 CRI			
CODE	WATT	RATE PER Pc. ₹	CUTOUT SIZE	OUTER DIMENSIONS	LUMENS*	PF	MINI PKG.	BULK PKG.
16409	8W	285/-	ϕ 52 mm	Ø 88 x 43 mm	600	>0.9	100	200
17512	12W	495/-	ϕ 38-127 mm	Ø 130 x 43 mm	840	>0.9	50	100



TRIO CONCEALED LIGHT		AC 220V - 240V		120° BEAM ANGLE	80 CRI			
CODE	WATT	RATE PER Pc. ₹	CUTOUT SIZE	OUTER DIMENSIONS	LUMENS*	PF	MINI PKG.	BULK PKG.
17203	3W	145/-	ϕ 60 mm	Ø 81 x 34 mm	225	>0.9	100	300
16406	6W	209/-	ϕ 80 mm	Ø 114 x 48 mm	450	>0.9	100	200
NEW 17532	12W	345/-	ϕ 103 mm	Ø 130 x 28 mm	900	>0.9	50	100

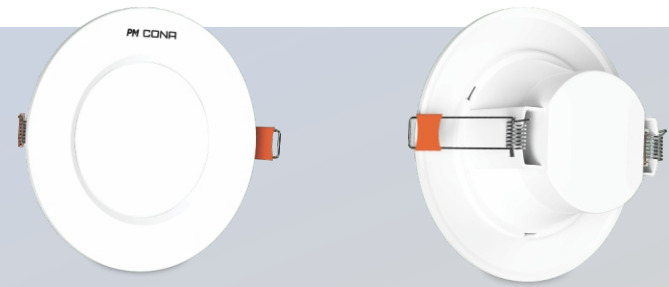

- LONG DISTANCE ILLUMINATION
- HIGH BRIGHTNESS
- SURGE PROTECTION
- ZERO MAINTENANCE

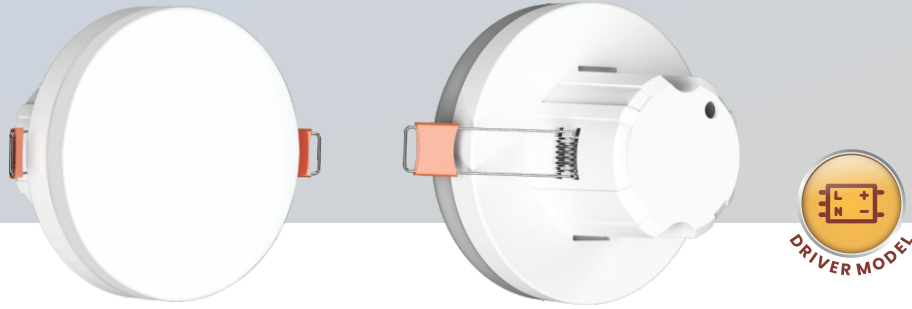

○ COOL LIGHT ● WARM LIGHT ● RED ● GREEN ● BLUE ● PINK

MOON CONCEALED LIGHT		AC 220V - 240V	120° BEAM ANGLE	80 CRI				
CODE	WATT	RATE PER Pc. ₹	CUTOUT SIZE	OUTER DIMENSIONS	LUMENS*	PF	MINI PKG.	BULK PKG.
16408	8W	209/-	ϕ 50 mm	Ø 84 x 68 mm	600	>0.9	100	200

○ COOL LIGHT ● WARM LIGHT

MOON CONCEALED LIGHT		AC 220V - 240V	120° BEAM ANGLE	80 CRI				
CODE	WATT	RATE PER Pc. ₹	CUTOUT SIZE	OUTER DIMENSIONS	LUMENS*	PF	MINI PKG.	BULK PKG.
16415	15W	485/-	ϕ 55 mm	Ø 140 x 65 mm	1200	>0.9	-	50



- LONG DISTANCE ILLUMINATION
- HIGH BRIGHTNESS
- SURGE PROTECTION
- ZERO MAINTENANCE



○ COOL LIGHT ● WARM LIGHT ● RED ● GREEN ● BLUE ● PINK

SPOT LIGHT		AC 220V - 240V	120° BEAM ANGLE	80 CRI				
CODE	WATT	RATE PER Pc. ₹	CUTOUT SIZE	OUTER DIMENSIONS	LUMENS*	PF	MINI PKG.	BULK PKG.
16402	2W	75/-	ϕ 35 mm	Ø 42 x 20 mm	140	>0.9	50	500

○ COOL LIGHT ● WARM LIGHT ● RED ● GREEN ● BLUE ● PINK

STRIKER SURFACE LIGHT		AC 220V - 240V	120° BEAM ANGLE	80 CRI				
CODE	WATT	RATE PER Pc. ₹	CUTOUT SIZE	OUTER DIMENSIONS	LUMENS*	PF	MINI PKG.	BULK PKG.
16403	3W	95/-	-	Ø 68 x 14 mm	225	>0.9	100	500



- LONG DISTANCE ILLUMINATION
- HIGH BRIGHTNESS
- SURGE PROTECTION
- ZERO MAINTENANCE



# MODERN COB LIGHTS

Transform your space with our LED COB Lights engineered for brilliance, efficiency, and longevity. Experience brighter, more vibrant lighting that enhances every detail, making your home or workplace shine like never before.

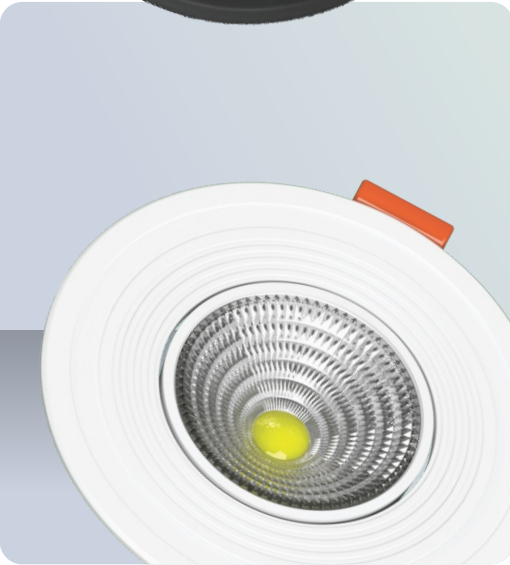

# APPLICATIONS

		
JEWELLERY SHOPS	KITCHEN SPACE	SHOWROOMS
		
SHELF SPACE	ART GALLERY	HOME INTERIOR

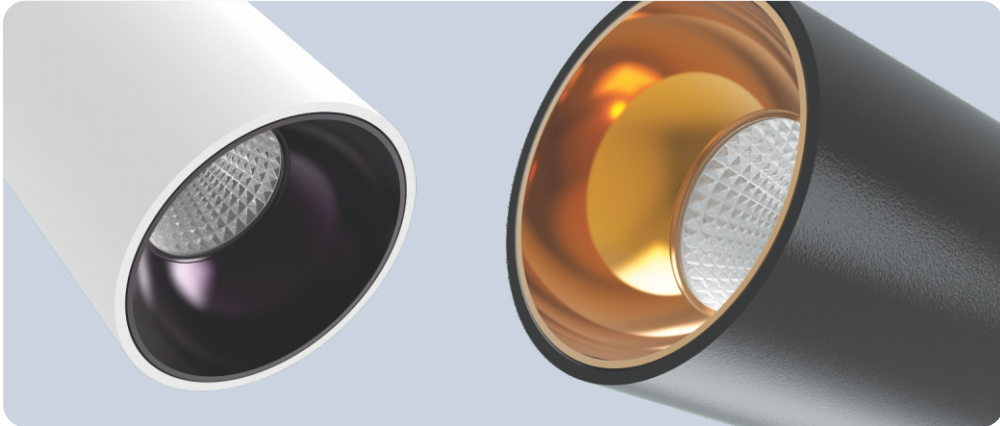

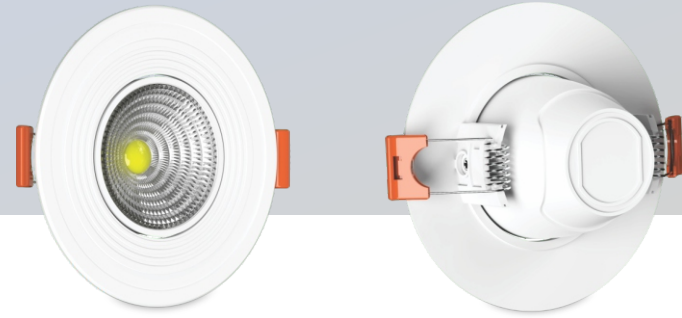

○ COOL LIGHT ● WARM LIGHT ● RED ● GREEN ● BLUE ● PINK

COB CONCEALED LIGHT PC BODY		AC 220V - 240V		120°	BEAM ANGLE	80	CRI	
CODE	WATT	RATE PER Pc. ₹	CUTOUT SIZE	OUTER DIMENSIONS	LUMENS*	PF	MINI PKG.	BULK PKG.
16904	4W	135/-	ϕ 55 mm	Ø 70 x 36 mm	280	>0.5	100	300
16907	7W	215/-	ϕ 75 mm	Ø 110 x 48 mm	490	>0.5	100	200

AVAILABLE COMBINATIONS

COMBO 1: R + B + P

COMBO 2: CL + NL + WL

COB TRIO CONCEALED LIGHT PC BODY		AC 220V - 240V		120°	BEAM ANGLE	80	CRI	
CODE	WATT	RATE PER Pc. ₹	CUTOUT SIZE	OUTER DIMENSIONS	LUMENS*	PF	MINI PKG.	BULK PKG.
16804	4W	195/-	ϕ 55 mm	Ø 70 x 36 mm	280	>0.5	100	300
16807	7W	295/-	ϕ 75 mm	Ø 110 x 48 mm	490	>0.5	100	200

ON ORDER

ON ORDER

Note: Availability of green highlighted products is on order basis.

- LONG DISTANCE ILLUMINATION
- HIGH BRIGHTNESS
- SURGE PROTECTION
- ZERO MAINTENANCE



WHITE BODY



BLACK BODY



○ COOL LIGHT ● WARM LIGHT ● NATURAL LIGHT

DEEP COB LIGHT		AC 220V - 240V		120°	BEAM ANGLE	80	CRI	
CODE	WATT	RATE PER Pc. ₹	CUTOUT SIZE	OUTER DIMENSIONS	LUMENS*	PF	MINI PKG.	BULK PKG.
16707	7W	595/-	ϕ 55 mm	Ø 65 x 55 mm	560	>0.9	50	100
16712	12W	755/-	ϕ 75 mm	Ø 85 x 79 mm	960	>0.9	50	100
16718	18W	1065/-	ϕ 90 mm	Ø 101 x 95 mm	1440	>0.9	30	60

- LONG DISTANCE ILLUMINATION
- HIGH BRIGHTNESS
- SURGE PROTECTION
- ZERO MAINTENANCE

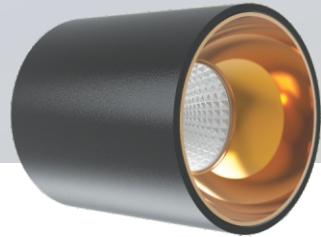
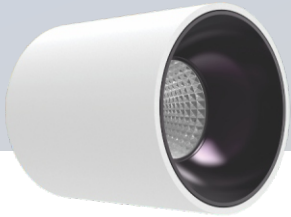

WHITE BODY & METAL BLACK REFLECTOR

BLACK BODY & COPPER GOLD REFLECTOR

COOL LIGHT  WARM LIGHT  NATURAL LIGHT

**CYLINDER SURFACE COB LIGHT**

AC 220V - 240V **120°** BEAM ANGLE **80** CRI

CODE	WATT	RATE PER Pc. ₹	CUTOUT SIZE	OUTER DIMENSIONS	LUMENS*	PF	MINI PKG.	BULK PKG.
<b>ON ORDER</b> 17707	<b>7W</b>	<b>695/-</b>	-	-	560	>0.9	-	50
<b>ON ORDER</b> 17712	<b>12W</b>	<b>925/-</b>	-	-	960	>0.9	-	50
<b>ON ORDER</b> 17718	<b>18W</b>	<b>1095/-</b>	-	-	1440	>0.9	-	20

**ON ORDER**

Note: Availability of green highlighted products is on order basis.



LONG DISTANCE ILLUMINATION



HIGH BRIGHTNESS



SURGE PROTECTION



ZERO MAINTENANCE





# MODERN ROPE LIGHT

Add a touch of brilliance with our LED Rope Lights versatile, flexible, and perfect for creating stunning ambiance. Whether indoors or out, these lights effortlessly enhance any space with a warm, inviting glow.

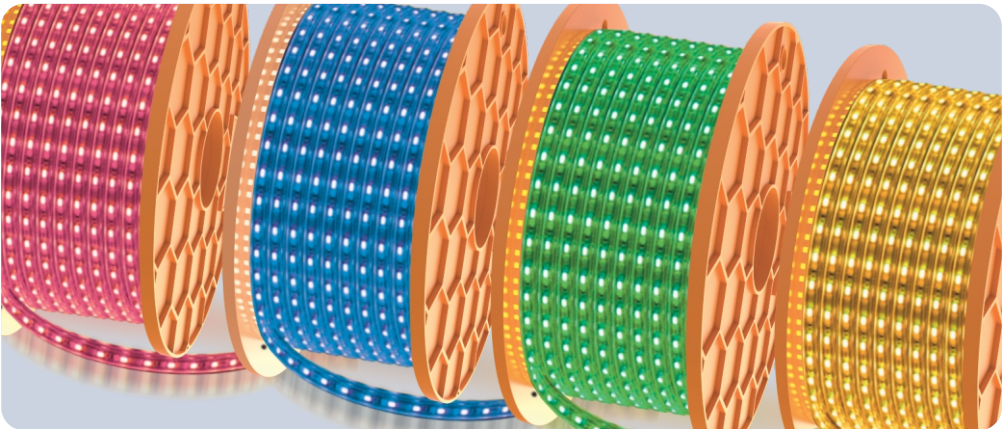

# APPLICATIONS

<p>DISCO &amp; CLUBS</p>	<p>MALLS</p>
<p>AMBIENT ATMOSPHERE</p>	<p>FESTIVALS &amp; DECORATION</p>



- COOL LIGHT
- WARM LIGHT
- GREEN
- PINK
- BLUE

### ROPE LIGHT WITH ADAPTOR

CODE	16450
LENGTH	<b>50 Mtr</b>
LED QUALITY	ULTRA SUPER BRIGHT
PRODUCT VOLTAGE	AC 220V - 240V
LED QTY.	120 Per Mtr
ADAPTOR QTY.	01
WATT PER MTR.	7W
RATE PER PC ₹	<b>5295/-</b>
BULK PKG.	03

### ROPE LIGHT ADAPTOR

CODE	16451
PRODUCT VOLTAGE	AC 220V - 240V
RATE PER PC ₹	<b>195/-</b>
BULK PKG.	100

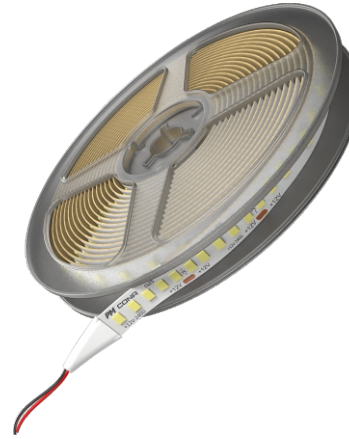

- COOL LIGHT
- WARM LIGHT
- NATURAL LIGHT

### STRIP LIGHT 240 LED

CODE	17015
LENGTH	5 Mtr
WIDTH	9.5 mm
LED QUALITY	ULTRA SUPER BRIGHT
PRODUCT VOLTAGE	AC 220V - 240V
LED QTY.	240 Per Mtr
RATE PER PC ₹	-
BOX PKG.	10
MINI PKG.	100
BULK PKG.	200

### STRIP LIGHT DRIVER 5Amp

CODE	16005
PRODUCT VOLTAGE	AC 220V - 240V
RATE PER PC ₹	-
BULK PKG.	-

### STRIP LIGHT DRIVER 10Amp

CODE	16010
PRODUCT VOLTAGE	AC 220V - 240V
RATE PER PC ₹	-
BULK PKG.	-

- LED SAVES UPTO 80% ENERGY
- NO HARMFUL UV/IR RADIATION
- IP 65 PROTECTION
- UPTO 15 TIMES LONGER LIFE APPROX 30000 Hrs LIFE

- FLEXIBLE STRIP FOR EASY BENDING.
- CUTTABLE LENGTH FOR SIZE ADJUSTMENT.
- Long lifespan up to 50,000 hours.
- HIGH BRIGHTNESS FOR CLEAR LIGHTING.

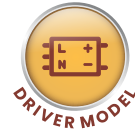
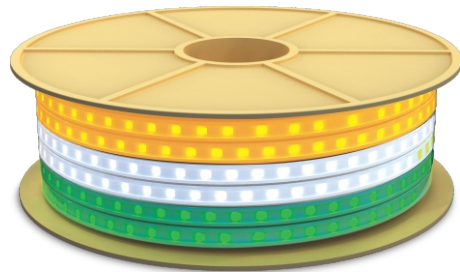

**ON**  
ORDER

**TRICOLOUR ROPE LIGHT**

CODE	17450
LENGTH	<b>18 Mtr</b>
LED QUALITY	ULTRA SUPER BRIGHT
PRODUCT VOLTAGE	AC 220V - 240V
LED QTY.	120 Per Mtr
ADAPTOR QTY.	01
WATT PER MTR.	7W
RATE PER PC ₹	<b>2295/-</b>
BULK PKG.	04



**ON**  
ORDER

Note: Availability of green highlighted products is on order basis.



LED SAVES UPTO 80% ENERGY



NO HARMFUL UV/IR RADIATION



IP 65 PROTECTION



UPTO 15 TIMES LONGER LIFE APPROX 30000 Hrs LIFE

# MODERN BATTEN LIGHT

Discover the elegance of our Batten Lights subtle yet powerful, they blend seamlessly into your space, offering soft, ambient lighting that enhances your room's aesthetics while providing efficient, shadow-free illumination.



# APPLICATIONS



HOSPITALS



RESIDENTIAL



BUNGALOWS



CORPORATE OFFICES



MALLS



RETAILS SHOP

IRIS

PM  
CONA



COOL LIGHT

## BATTEN LIGHT

AC 220V - 240V

120° BEAM ANGLE 80 CRI

CODE	WATT	RATE PER Pc. ₹	CUTOUT SIZE	OUTER DIMENSIONS	LUMENS*	PF	MINI PKG.	BULK PKG.
16420	20W	285/-	-	Ø 1070 x 23 x 32 mm	2000	>0.9	40	120
16422	22W	295/-	-	Ø 1130 x 23 x 38 mm	2200	>0.9	40	120
16436	36W	555/-	-	Ø 1180 x 29 x 40 mm	3600	>0.9	25	100
NEW 16452	52W	1095/-	-	Ø 1100 x 55 x 39 mm	5200	>0.9	15	30
16472	72W	1429/-	-	Ø 1100 x 55 x 39 mm	7200	>0.9	15	30



ROBUST DESIGN



HIGH BRIGHTNESS



SURGE PROTECTION



FLICKER FREE

# MODERN LED BULB

Brighten every corner with our LED Bulbs energy efficient, long-lasting, and designed to deliver superior illumination. Perfect for any room, these bulbs provide clear, vibrant light while saving on energy costs.



SAVE ENERGY,  
SAVE MONEY

Energy savings up to 90%\*



# APPLICATIONS



HOSPITALS



RESIDENTIAL



BUNGALOWS



CORPORATE OFFICES



GENERAL PURPOSE



RETAILS SHOP

## LUNAR



COOL LIGHT  YELLOW  RED  GREEN  BLUE  PINK

LED BULB		AC 220V - 240V	UPTO 240°	BEAM ANGLE	80	CRI		
CODE	WATT	RATE PER Pc. ₹	CUTOUT SIZE	OUTER DIMENSIONS	LUMENS*	PF	MINI PKG.	BULK PKG.
17005	0.5W	55/-	-	-	50	>0.9	60	180

COOL LIGHT

LED BULB		AC 220V - 240V	UPTO 240°	BEAM ANGLE	80	CRI		
CODE	WATT	RATE PER Pc. ₹	CUTOUT SIZE	OUTER DIMENSIONS	LUMENS*	PF	MINI PKG.	BULK PKG.
17605	5W	95/-	-	-	500	>0.9	50	200
17617	7W	95/-	-	-	700	>0.9	50	200
17609	9W	95/-	-	-	900	>0.9	50	200
17612	12W	155/-	-	-	1200	>0.9	40	80
17615	15W	195/-	-	-	1500	>0.9	40	80

HIGHER WATTAGE LED BULB		AC 220V - 240V	UPTO 240°	BEAM ANGLE	80	CRI		
CODE	WATT	RATE PER Pc. ₹	CUTOUT SIZE	OUTER DIMENSIONS	LUMENS*	PF	MINI PKG.	BULK PKG.
17620	20W	305/-	-	-	2000	>0.9	30	60
17630	30W	445/-	-	-	3000	>0.9	20	40
17640	40W	625/-	-	-	4000	>0.9	20	40
17650	50W	775/-	-	-	5000	>0.9	20	40

LUNAR LED EMERGENCY BULB		AC 220V - 240V	UPTO 240°	BEAM ANGLE	80	CRI		
CODE	WATT	RATE PER Pc. ₹	CUTOUT SIZE	OUTER DIMENSIONS	LUMENS*	PF	MINI PKG.	BULK PKG.
17619	9W	555/-	-	-	900	>0.9	25	100



B22 FITTING



POWER SAVING



LONGER LIFE



NO UV LIGHT



# MODERN FLOOD LIGHT

Light up large areas with our high-performance LED Flood Lights. Engineered for durability and maximum brightness, these lights are perfect for security, landscaping, and outdoor events. Designed to withstand the elements, our flood lights deliver reliable, energy-efficient illumination, ensuring your outdoor spaces are safe, secure, and brilliantly lit.

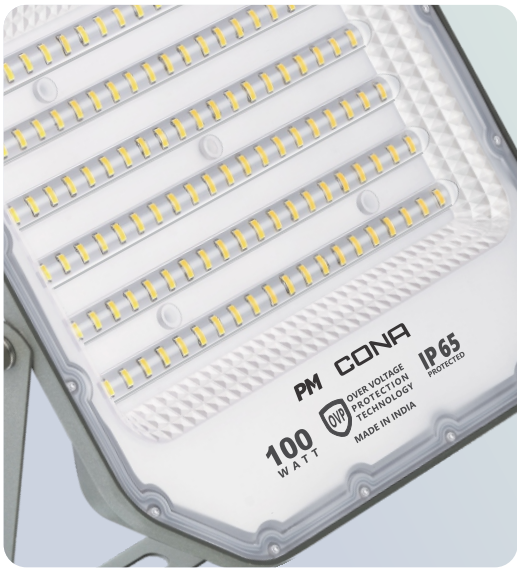

# APPLICATIONS

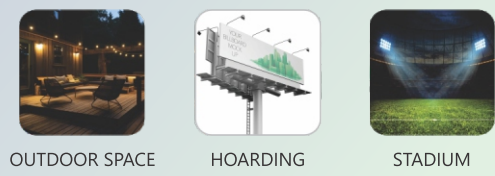

OUTDOOR SPACE    HOARDING    STADIUM

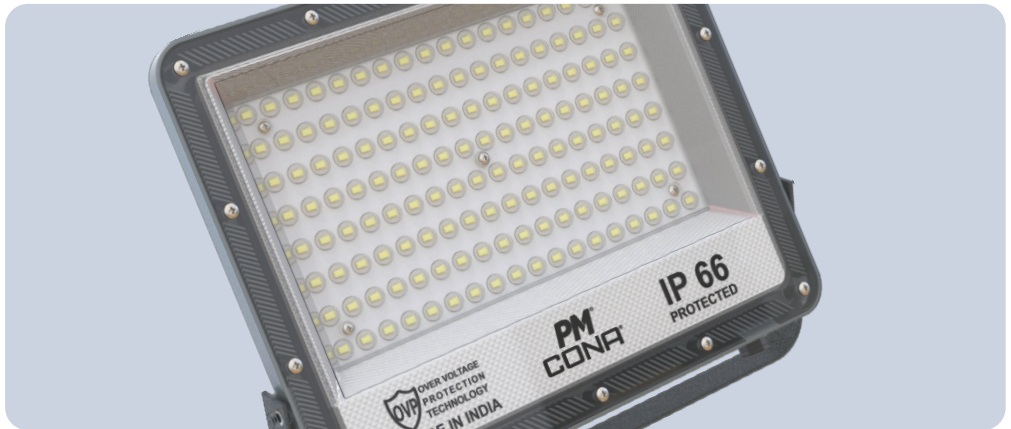

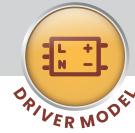

COOL LIGHT

FLASH LENS FLOOD LIGHT		AC 220V - 240V	120° BEAM ANGLE	80 CRI				
CODE	WATT	RATE PER Pc. ₹	CUTOUT SIZE	OUTER DIMENSIONS	LUMENS*	PF	MINI PKG.	BULK PKG.
16530	30W	1075/-	-	Ø 170 x 150 x 31 mm	2850	>0.9	-	20
16550	50W	1395/-	-	Ø 200 x 180 x 31 mm	4750	>0.9	-	20
16600	100W	2295/-	-	Ø 250 x 230 x 31 mm	9500	>0.9	-	10

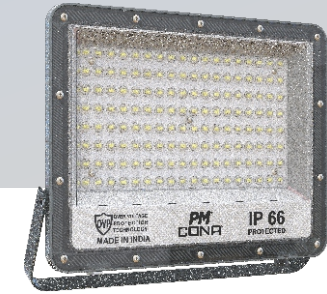

COOL LIGHT

SMART LENS FLOOD LIGHT		AC 220V - 240V	90° BEAM ANGLE	80 CRI	IP66 PROTECTION			
CODE	WATT	RATE PER Pc. ₹	CUTOUT SIZE	OUTER DIMENSIONS	LUMENS*	PF	MINI PKG.	BULK PKG.
17050	50W	1455/-	-	Ø 185 x 145 x 23.5 mm	5000	>0.9	10	40
17100	100W	2395/-	-	Ø 245 x 193 x 23.5 mm	10000	>0.9	10	20

COOL LIGHT

SMART LENS FLOOD LIGHT		AC 220V - 240V	90° BEAM ANGLE	80 CRI	IP66 PROTECTION			
CODE	WATT	RATE PER Pc. ₹	CUTOUT SIZE	OUTER DIMENSIONS	LUMENS*	PF	MINI PKG.	BULK PKG.
17010	10W	645/-	-	-	1000	>0.9	20	40
17020	20W	745/-	-	-	2000	>0.9	20	40
NEW 17030	30W	995/-	-	Ø 153 x 128 x 23.5 mm	3000	>0.9	20	40
17150	150W	3595/-	-	Ø 305 x 230 x 23.5 mm	15000	>0.9	-	5
17200	200W	4495/-	-	Ø 352 x 260 x 23.5 mm	20000	>0.9	-	5

**ON ORDER**

Note: Availability of green highlighted products is on order basis.

- LONG DISTANCE ILLUMINATION
- HIGH BRIGHTNESS
- SURGE PROTECTION
- ZERO MAINTENANCE

- LONG DISTANCE ILLUMINATION
- HIGH BRIGHTNESS
- SURGE PROTECTION
- ZERO MAINTENANCE



# MODERN STREET LIGHT

Illuminate streets, pathways, and public spaces with our advanced LED Street Lights. Engineered for longevity and energy efficiency, these lights provide bright, consistent illumination to enhance safety and visibility. Built to withstand harsh weather conditions, our LED Street Lights are the reliable choice for keeping your community well-lit and secure, night after night.

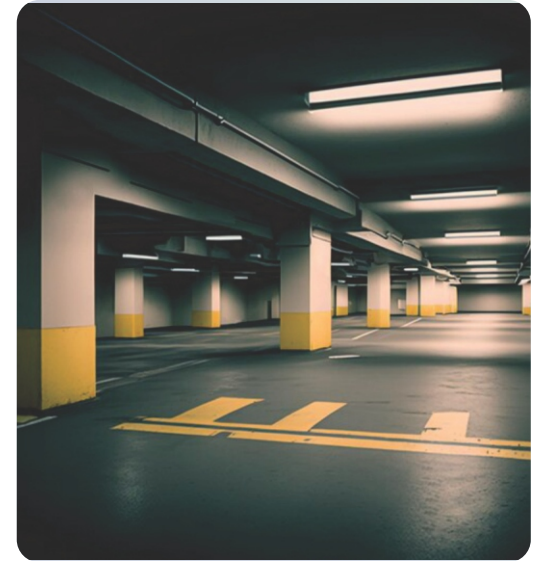

# APPLICATIONS



STREETS



PARKING SPACE



LAWN & GARDENS



OUTDOOR SPACE

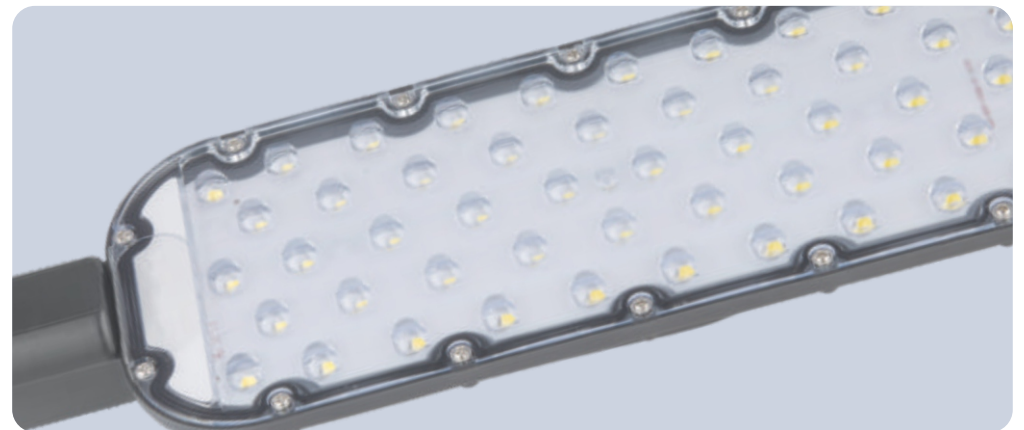



COOL LIGHT

MAX LENS STREET LIGHT		AC 220V - 240V		120° BEAM ANGLE	80 CRI			
CODE	WATT	RATE PER Pc. ₹	CUTOUT SIZE	OUTER DIMENSIONS	LUMENS*	PF	MINI PKG.	BULK PKG.
16220	20W	955/-	-	Ø 263 x 116 x 58 mm	1900	>0.9	-	20
16230	30W	1245/-	-	Ø 298 x 135 x 58 mm	2850	>0.9	-	20
16251	50W	1555/-	-	Ø 345 x 170 x 62 mm	4750	>0.9	-	20
16300	100W	2795/-	-	Ø 385 x 200 x 74 mm	9500	>0.9	-	10
16650	150W	3695/-	-	-	14250	>0.9	-	-
16700	200W	4695/-	-	-	19000	>0.9	-	-

COOL LIGHT  WARM LIGHT

SMART LENS STREET LIGHT PC BODY		AC 220V - 240V		90° BEAM ANGLE	80 CRI	IP66 PROTECTION			
CODE	WATT	RATE PER Pc. ₹	CUTOUT SIZE	OUTER DIMENSIONS	LUMENS*	PF	MINI PKG.	BULK PKG.	
17230	30W	1275/-	-	Ø 335 x 105 x 8 mm	3000	>0.9	10	20	
17250	50W	1495/-	-	Ø 395 x 128 x 8 mm	5000	>0.9	10	20	



COOL LIGHT

SOLAR STREET LIGHT		AC 220V - 240V		80 CRI	IP66 PROTECTION			
CODE	WATT	RATE PER Pc. ₹	CUTOUT SIZE	OUTER DIMENSIONS	LUMENS*	PF	MINI PKG.	BULK PKG.
ON > ORDER	16430	30W	2495/-	-	-	-	-	-
ON > ORDER	16360	60W	2995/-	-	-	-	-	-
ON > ORDER	16500	100W	3895/-	-	-	-	-	-
ON > ORDER	16750	150W	5195/-	-	-	-	-	-
ON > ORDER	16800	200W	6295/-	-	-	-	-	-

COOL LIGHT

SENSOR STREET LIGHT		AC 220V - 240V		90° BEAM ANGLE	80 CRI	IP66 PROTECTION			
CODE	WATT	RATE PER Pc. ₹	CUTOUT SIZE	OUTER DIMENSIONS	LUMENS*	PF	MINI PKG.	BULK PKG.	
ON > ORDER	16350	50W	2695/-	-	Ø 390 x 163 x 3 mm	4750	>0.9	20	
ON > ORDER	16400	100W	3195/-	-	Ø 185 x 455 x 4 mm	9500	>0.9	10	



Note: Availability of green highlighted products is on order basis.



LONG DISTANCE ILLUMINATION



HIGH BRIGHTNESS



SURGE PROTECTION



ZERO MAINTENANCE



LONG DISTANCE ILLUMINATION



HIGH BRIGHTNESS



SURGE PROTECTION



ZERO MAINTENANCE

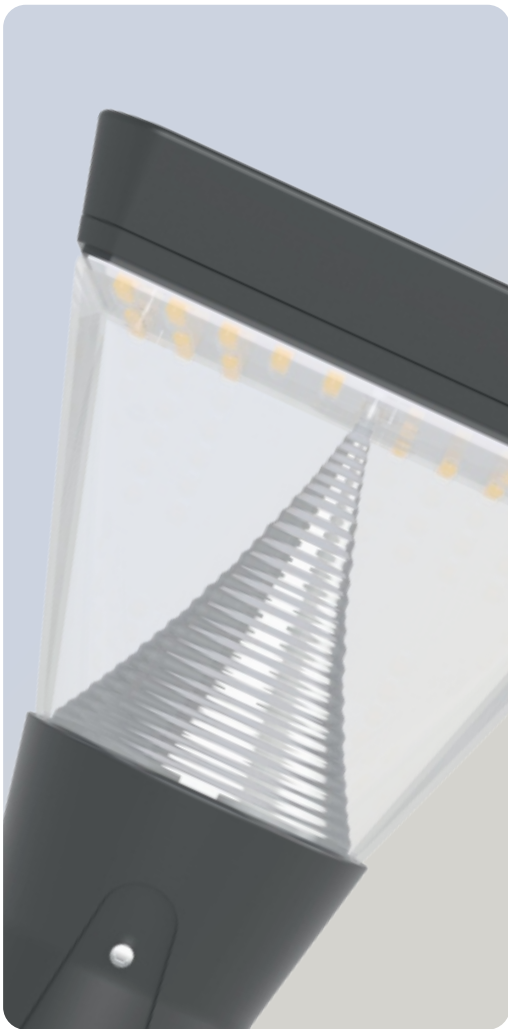

# MODERN OUTDOOR LIGHT

Add a touch of brilliance with our LED Outdoor Lights versatile, flexible, and perfect for creating stunning ambiance. These lights effortlessly enhance any space with a warm, inviting glow.



# APPLICATIONS

		
GATE	LAWN & GARDENS	BALCONIES
		
DRIVEWAYS	LAWN & GARDENS	COMMERCIAL AREA

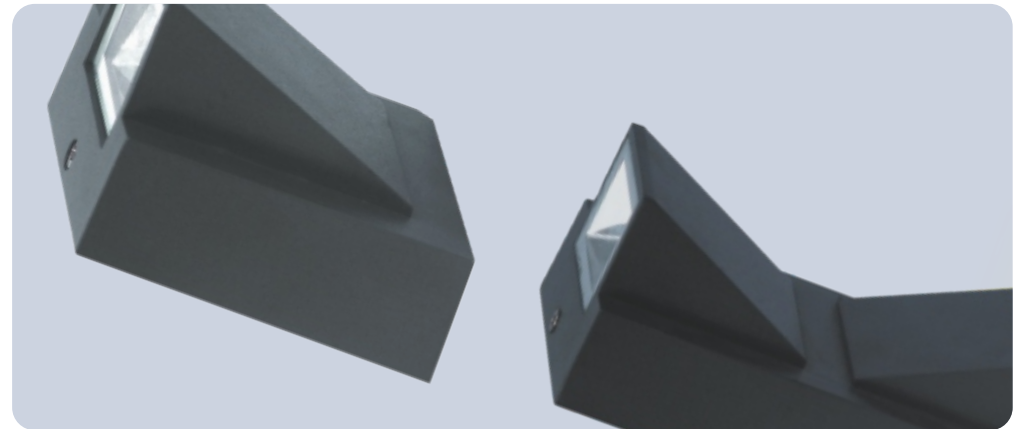



COOL LIGHT  WARM LIGHT AC 220V - 240V 120° BEAM ANGLE 80 CRI IP65 PROTECTION

CAPSULE BULKHEAD LIGHT								
CODE	WATT	RATE PER Pc. ₹	CUTOUT SIZE	OUTER DIMENSIONS	LUMENS*	PF	MINI PKG.	BULK PKG.
16910	10W	235/-	-	Ø 170 x 70 x 45.5 mm	750	>0.9	-	80
16920	20W	395/-	-	Ø 210 x 100 x 56 mm	1700	>0.9	-	40

WARM LIGHT AC 220V - 240V 120° BEAM ANGLE 80 CRI IP65 PROTECTION

K WALL LIGHT 1 WAY (Aluminium body)								
CODE	WATT	RATE PER Pc. ₹	CUTOUT SIZE	OUTER DIMENSIONS	LUMENS*	PF	MINI PKG.	BULK PKG.
17513	3W	775/-	-	Ø 76 x 80 x 65 mm	240	>0.9	-	50

K WALL LIGHT 2 WAY (Aluminium body)								
CODE	WATT	RATE PER Pc. ₹	CUTOUT SIZE	OUTER DIMENSIONS	LUMENS*	PF	MINI PKG.	BULK PKG.
17516	6W	935/-	-	Ø 145 x 80 x 65a mm	480	>0.9	-	50

GARDEN SPIKE LIGHT (Aluminium body)								
CODE	WATT	RATE PER Pc. ₹	CUTOUT SIZE	OUTER DIMENSIONS	LUMENS*	PF	MINI PKG.	BULK PKG.
17507	5W	685/-	-	Ø 240 X 80 x 60 mm	400	>0.6	20	60

- ROBUST DESIGN
- HIGH BRIGHTNESS
- SURGE PROTECTION
- ZERO MAINTENANCE

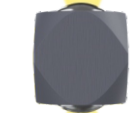

WARM LIGHT

AC 220V - 240V 120° BEAM ANGLE 80 CRI IP65 PROTECTION

WALL LIGHT 1 WAY (Aluminium body)									
CODE	WATT	RATE PER Pc. ₹	CUTOUT SIZE	OUTER DIMENSIONS	LUMENS*	PF	MINI PKG.	BULK PKG.	
ON ORDER 17501	1W	585/-	-	Ø 53 X 40 x 40 mm	100	>0.6	20	100	

WALL LIGHT 2 WAY SMALL (Aluminium body)									
CODE	WATT	RATE PER Pc. ₹	CUTOUT SIZE	OUTER DIMENSIONS	LUMENS*	PF	MINI PKG.	BULK PKG.	
ON ORDER 17502	3W	655/-	-	Ø 53 X 40 x 40 mm	200	>0.6	20	100	

WALL LIGHT 3 WAY (Aluminium body)									
CODE	WATT	RATE PER Pc. ₹	CUTOUT SIZE	OUTER DIMENSIONS	LUMENS*	PF	MINI PKG.	BULK PKG.	
ON ORDER 17503	5W	1495/-	-	Ø 195 X 195 x 195 mm	300	>0.6	-	20	

WALL LIGHT 4 WAY (Aluminium body)									
CODE	WATT	RATE PER Pc. ₹	CUTOUT SIZE	OUTER DIMENSIONS	LUMENS*	PF	MINI PKG.	BULK PKG.	
ON ORDER 17504	5W	1275/-	-	Ø 75 X 75 x 52 mm	400	>0.6	20	40	

WALL LIGHT 2 WAY (Aluminium body)									
CODE	WATT	RATE PER Pc. ₹	CUTOUT SIZE	OUTER DIMENSIONS	LUMENS*	PF	MINI PKG.	BULK PKG.	
ON ORDER 17505	3W	745/-	-	Ø 53 X 45 x 45 mm	200	>0.6	20	40	

WALL LIGHT 2 WAY UP - DOWN (Aluminium body)									
CODE	WATT	RATE PER Pc. ₹	CUTOUT SIZE	OUTER DIMENSIONS	LUMENS*	PF	MINI PKG.	BULK PKG.	
ON ORDER 17506	3W	745/-	-	Ø 115 X 35 x 45 mm	200	>0.6	20	40	

**ON ORDER** Note: Availability of green highlighted products is on order basis.



COOL LIGHT  WARM LIGHT

MINI STAR LED GATE LIGHT		AC 220V - 240V		90° BEAM ANGLE	80 CRI	IP66 PROTECTION		
CODE	WATT	RATE PER Pc. ₹	CUTOUT SIZE	OUTER DIMENSIONS	LUMENS*	PF	MINI PKG.	BULK PKG.
17220	20W	1695/-	-	Ø 175 x 175 X 225 mm	1800	>0.9	-	18

COOL LIGHT  WARM LIGHT

MEGA STAR LED GATE LIGHT		AC 220V - 240V		90° BEAM ANGLE	80 CRI	IP66 PROTECTION		
CODE	WATT	RATE PER Pc. ₹	CUTOUT SIZE	OUTER DIMENSIONS	LUMENS*	PF	MINI PKG.	BULK PKG.
17224	24W	1295/-	-	Ø 175 x 175 X 225 mm	2400	>0.9	-	24



ROBUST DESIGN



HIGH BRIGHTNESS



SURGE PROTECTION



ZERO MAINTENANCE



# MODERN HIGHBAY LIGHT

Light up large areas with our high-performance LED Highbay Lights. Engineered for durability and maximum brightness, these lights are perfect for security, landscaping, and outdoor events. Designed to withstand the elements, our Highbay lights deliver reliable, energy-efficient illumination, ensuring your outdoor spaces are safe, secure, and brilliantly lit.

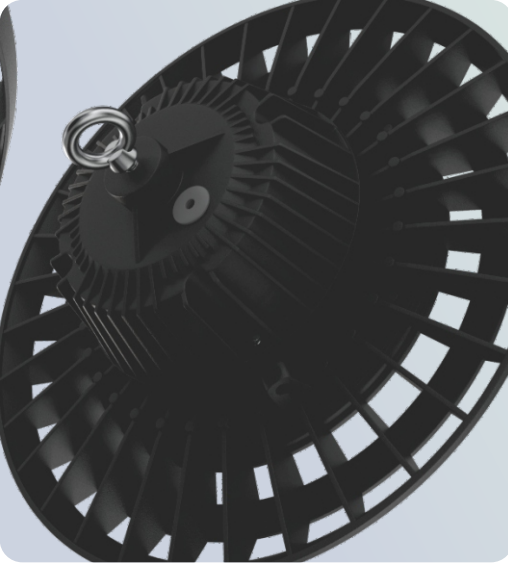

# APPLICATIONS



WAREHOUSES



FACTORIES



GYMNASIUMS



AIRPLANE HANGARS



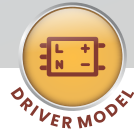
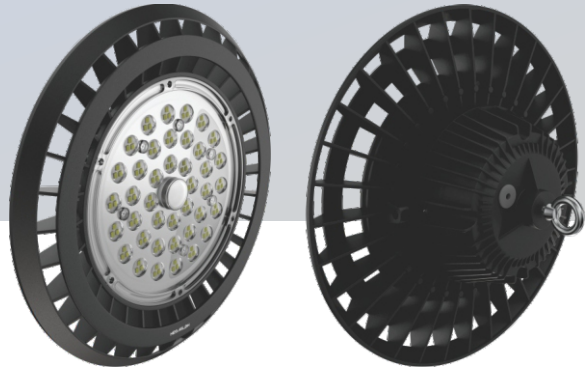

COOL LIGHT

**UFO HIGHBAY LIGHT** AC 220V - 240V **90°** BEAM ANGLE **80** CRI **IP66** PROTECTION

CODE	WATT	RATE PER Pc. ₹	CUTOUT SIZE	OUTER DIMENSIONS	LUMENS*	PF	MINI PKG.	BULK PKG.
<b>ON ORDER</b> 17500	<b>100W</b>	<b>4595/-</b>	-	Ø 285 mm	14000	>0.9	-	8
<b>ON ORDER</b> 17550	<b>150W</b>	<b>6395/-</b>	-	Ø 360 mm	21000	>0.9	-	8
<b>ON ORDER</b> 17600	<b>200W</b>	<b>6595/-</b>	-	Ø 360 mm	28000	>0.9	-	8



**ON ORDER** Note: Availability of green highlighted products is on order basis.



LONG DISTANCE ILLUMINATION



HIGH BRIGHTNESS



SURGE PROTECTION



ZERO MAINTENANCE

# ASSURE

RANGE

## YOUR WORLD'S SAFETY - ASSURED







PM CONA has always pledged for the protection of its consumers; hence we have always been recognised as the finest Producer of Top-Class MCB Range.

ASSURE MCBs are furnished with High Making & Breaking Capacity. They are 100% Shielded & Crafted to function perfectly under both Overload & Short Circuit situations.

ASSURE MCBs unique SVD - Smart Ventilation Design helps in protection against high heating situations and ensures longer life and high safety standards. SVD also works when more than one SP MCBs are stacked together.

Made to last for a lifetime and comes with a 4 years Warranty, its internal parts are made with high grade materials which helps you sleep peacefully at night.

It comes with a Striking & Modern Design which will always seem to be New in the coming years & it has a Ultra Smooth Finish Texture which is easy to install.

-  High Making & Breaking Capacity
-  Heavy Duty Parts
-  Short Circuit & Overload Protection
-  High Heat Resistant Body
-  Silver Cadmium For High Conductivity
-  High Precision Engineering Design



Assure DP Isolator 40A



Assure SP MCB 16A

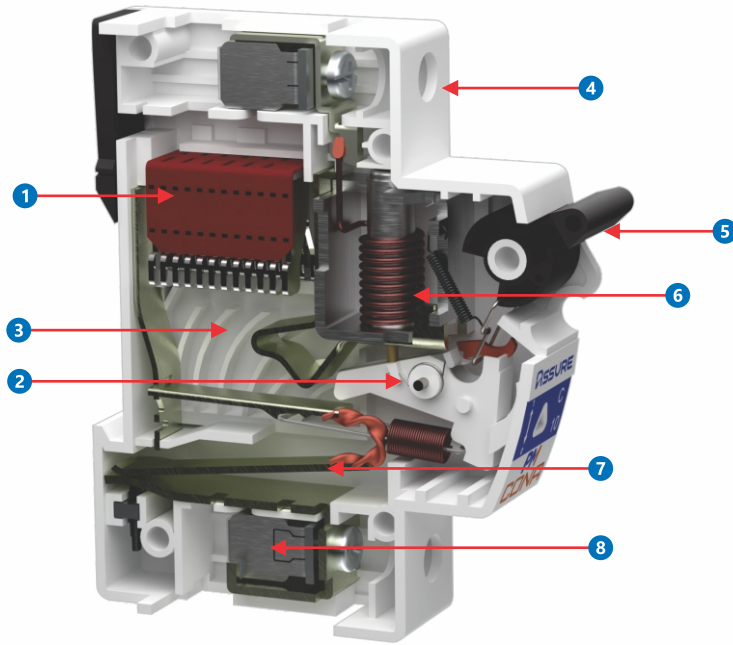

- |                                    |   |
|------------------------------------|---|
| 1. ARC EXTINCTION CHAMBER          | 5. OPERATING KNOB                         |
| 2. OPERATING MECHANISM             | 6. ELECTRO MAGNETIC PROTECTION (SOLENOID) |
| 3. ELECTRIC ARC DIFFUSER           | 7. THERMAL PROTECTION BI-METAL            |
| 4. TOUGH DURABLE & FIRE PROOF BODY | 8. TERMINAL                               |



## Miniature Circuit Breakers "C" Type

240/415 V Ac 50 Hz Supply (Breaking Capacity 10 kA)

**10 POINTS**  
(SP MCB per PC)

**20 POINTS**  
(Multi Pole MCB per PC)

	SP					SPN					DP				
	CODE	RATE PER Pc. ₹	BOX PKG.	MINI PKG.	BULK PKG.	CODE	RATE PER Pc. ₹	BOX PKG.	MINI PKG.	BULK PKG.	CODE	RATE PER Pc. ₹	BOX PKG.	MINI PKG.	BULK PKG.
<b>6A</b>	23106	<b>235/-</b>	12	60	300	23206	<b>595/-</b>	6	30	150	23306	<b>615/-</b>	6	30	150
<b>10A</b>	23110	<b>235/-</b>	12	60	300	23210	<b>595/-</b>	6	30	150	23310	<b>615/-</b>	6	30	150
<b>16A</b>	23116	<b>235/-</b>	12	60	300	23216	<b>595/-</b>	6	30	150	23316	<b>615/-</b>	6	30	150
<b>20A</b>	23120	<b>235/-</b>	12	60	300	23220	<b>595/-</b>	6	30	150	23320	<b>615/-</b>	6	30	150
<b>25A</b>	23125	<b>235/-</b>	12	60	300	23225	<b>595/-</b>	6	30	150	23325	<b>615/-</b>	6	30	150
<b>32A</b>	23132	<b>235/-</b>	12	60	300	23232	<b>595/-</b>	6	30	150	23332	<b>615/-</b>	6	30	150
<b>40A</b>	23140	<b>385/-</b>	12	60	300	23240	<b>815/-</b>	6	30	150	23340	<b>865/-</b>	6	30	150
<b>63A</b>	23163	<b>475/-</b>	12	60	300	23263	<b>855/-</b>	6	30	150	23363	<b>985/-</b>	6	30	150

	TP					TPN					FP				
	CODE	RATE PER Pc. ₹	BOX PKG.	MINI PKG.	BULK PKG.	CODE	RATE PER Pc. ₹	BOX PKG.	MINI PKG.	BULK PKG.	CODE	RATE PER Pc. ₹	BOX PKG.	MINI PKG.	BULK PKG.
<b>6A</b>	23406	<b>1015/-</b>	4	20	100	23506	<b>1275/-</b>	3	15	75	23606	<b>1395/-</b>	3	15	75
<b>10A</b>	23410	<b>1015/-</b>	4	20	100	23510	<b>1275/-</b>	3	15	75	23610	<b>1395/-</b>	3	15	75
<b>16A</b>	23416	<b>1015/-</b>	4	20	100	23516	<b>1275/-</b>	3	15	75	23616	<b>1395/-</b>	3	15	75
<b>20A</b>	23420	<b>1015/-</b>	4	20	100	23520	<b>1275/-</b>	3	15	75	23620	<b>1395/-</b>	3	15	75
<b>25A</b>	23425	<b>1015/-</b>	4	20	100	23525	<b>1275/-</b>	3	15	75	23625	<b>1395/-</b>	3	15	75
<b>32A</b>	23432	<b>1015/-</b>	4	20	100	23532	<b>1275/-</b>	3	15	75	23632	<b>1395/-</b>	3	15	75
<b>40A</b>	23440	<b>1345/-</b>	4	20	100	23540	<b>1595/-</b>	3	15	75	23640	<b>1825/-</b>	3	15	75
<b>63A</b>	23463	<b>1495/-</b>	4	20	100	23563	<b>1845/-</b>	3	15	75	23663	<b>2095/-</b>	3	15	75

Rating	Suggested Use
<b>6A</b>	<b>Domestic Lighting, Fan, Electric Iron.</b>
<b>10A</b>	<b>0.50 Ton A/C, Washing Machine (upto 1800), Television.</b>
<b>16A</b>	<b>1.00 Ton A/C, Microwave, Oven, Water Heater.</b>
<b>20A</b>	<b>Mixer, Refrigerator, Table Fan, Light.</b>
<b>25A</b>	<b>1.50 Ton A/C, Room Heater.</b>
<b>32A</b>	<b>2.00 Ton A/C, 6 k. v. Water Heater, Small Industrial Equipment.</b>
<b>40A</b>	<b>1.5 Ton A/C + 1000V Water Heater + Refrigerator.</b>
<b>63A</b>	<b>2.5 Ton A/C + 2 H. P. Domestic Pump + Heater + Light + Fan.</b>

# ASSURE RANGE



## Isolator

20 POINTS  
(per PC)

	DP					FP				
	CODE	RATE PER Pc. ₹	BOX PKG.	MINI PKG.	BULK PKG.	CODE	RATE PER Pc. ₹	BOX PKG.	MINI PKG.	BULK PKG.
40A	24240	435/-	6	30	150	24440	925/-	3	15	75
63A	24263	555/-	6	30	150	24463	1125/-	3	15	75



## Residual Current Circuit Breakers 240/415 V Ac 50 Hz Supply

20 POINTS  
(per PC)

	DP							FP						
	30 mA			100 mA				30 mA			100 mA			
	CODE	RATE PER Pc. ₹	CODE	RATE PER Pc. ₹	BOX PKG.	MINI PKG.	BULK PKG.	CODE	RATE PER Pc. ₹	CODE	RATE PER Pc. ₹	BOX PKG.	MINI PKG.	BULK PKG.
25A	24625	2045/-	24725	2045/-	6	30	90	-	-	-	-	-	-	-
40A	24640	2045/-	24740	2045/-	6	30	90	24840	3295/-	24940	3295/-	3	15	45
63A	24663	2245/-	24763	2245/-	6	30	90	24863	3295/-	24963	3295/-	3	15	45



## Changeover 240/415 V Ac 50 Hz Supply

20 POINTS  
(per PC)

	DP					FP				
	CODE	RATE PER Pc. ₹	BOX PKG.	MINI PKG.	BULK PKG.	CODE	RATE PER Pc. ₹	BOX PKG.	MINI PKG.	BULK PKG.
25A	25225	795/-	6	30	150	25425	1595/-	3	15	75
40A	25240	1025/-	6	30	150	25440	2045/-	3	15	75
63A	25263	1395/-	6	30	150	25463	2495/-	3	15	75

PM CONA Change-over MCBs are mounted on Din-Channel & should be fitted in Distribution Board along with MCBs thus saving space and cost of fitting.



**ON ORDER** Note: Availability of ACCL products is on order basis.

## NEW Automatic Changeover With Current Limiter

20 POINTS  
(per PC)

	ACCL SPN										
	CODE	RATE PER Pc. ₹	BOX PKG.	MINI PKG.	BULK PKG.	CODE	RATE PER Pc. ₹	BOX PKG.	MINI PKG.	BULK PKG.	
1.5A	25001	2695/-	6	-	60	10A	25010	2695/-	6	-	60
2.5A	25002	2695/-	6	-	60	15A	25015	2695/-	6	-	60
6A	25006	2695/-	6	-	60	20A	25020	2695/-	6	-	60

- Micro Controller Based Design
- Led Indication of All Operating Status
- Compact in Size (TP MCB Size)
- Din Rail Mountable
- Less Power Consumption



**ON**  
**ORDER**

Note: Availability of MCCB products is on order basis.

## NEW Moulded Case Circuit Breaker

**20 POINTS**  
(per PC)

	TP					FP				
	CODE	RATE PER Pc. ₹	BOX PKG.	MINI PKG.	BULK PKG.	CODE	RATE PER Pc. ₹	BOX PKG.	MINI PKG.	BULK PKG.
<b>100A</b>	26100	<b>3795/-</b>	1	-	20	26300	<b>4995/-</b>	1	-	10
<b>200A</b>	26200	<b>10995/-</b>	1	-	20	26400	<b>13995/-</b>	1	-	10

-  Compact Size & Robust Design
-  Push to Trip Button
-  Higher Current Ratings
-  Overload & Short Circuit protection
-  Suitable for Isolation
-  Ensures Operational Safety and Reliability



**NEW**

## BUSBAR

	CODE	RATE PER Pc. ₹	BOX PKG.	BULK PKG.
<b>32A/415V</b>	25032	<b>2895/-</b>	1	5
<b>63A/415V</b>	25063	<b>4195/-</b>	1	3
<b>100A/415V</b>	25100	<b>6495/-</b>	1	2
<b>200A/415V</b>	25200	<b>10995/-</b>	1	2

-  Simplified Distribution
-  Enhanced Protection
-  Easy Concept & Operation
-  Overload & Short Circuit protection
-  Durable Construction



**NEW**

MAIN SWITCH				
	CODE	RATE PER Pc. ₹	BOX PKG.	BULK PKG.
<b>DP 16A/240V</b>	25716	<b>1045/-</b>	1	20
<b>DP 32A/240V</b>	25732	<b>1995/-</b>	1	10
<b>TPN 32A/415V</b>	25832	<b>3045/-</b>	1	5
<b>DP 63A/240V</b>	25763	<b>3045/-</b>	1	4
<b>TPN 63A/415V</b>	25863	<b>7095/-</b>	1	3
<b>TPN 100A/415V</b>	25800	<b>11995/-</b>	1	2



**NEW**

CHANGEOVER				
	CODE	RATE PER Pc. ₹	BOX PKG.	BULK PKG.
<b>DP 32A/240V</b>	25232	<b>2095/-</b>	1	10
<b>FP 32A/415V</b>	25432	<b>3995/-</b>	1	5
<b>DP 63A/240V</b>	26263	<b>5795/-</b>	1	4
<b>FP 63A/415V</b>	26463	<b>9995/-</b>	1	3
<b>FP 100A/415V</b>	25415	<b>15995/-</b>	1	2
<b>FP 200A/415V</b>	25515	<b>26995/-</b>	1	2

## Distribution Boards (Sheet Enclosures)

With Busbar, Neutral Link And Channel Without MCB

BOLD DB'S				
	CODE	RATE PER Pc. ₹	BOX PKG.	BULK PKG.
<b>4 Way SPN</b>	24104	<b>1295/-</b>	1	20
<b>6 Way SPN</b>	24106	<b>1495/-</b>	1	18
<b>8 Way SPN</b>	24108	<b>1595/-</b>	1	16
<b>10 Way SPN</b>	24110	<b>1895/-</b>	1	14
<b>12 Way SPN</b>	24112	<b>2245/-</b>	1	12
<b>16 Way SPN</b>	24116	<b>2595/-</b>	1	9

	CODE	RATE PER Pc. ₹	BOX PKG.	BULK PKG.
<b>4 Way TPN</b>	24304	<b>3995/-</b>	1	4
<b>6 Way TPN</b>	24306	<b>4495/-</b>	1	4
<b>8 Way TPN</b>	24308	<b>4995/-</b>	1	3

- THIS PRODUCT IS MADE WITH PRE-GALVANIZED/PRE-COATED (EG/GA/GP/GPSP) SHEET FOR RUST RESISTANCE.
- TEXTURE FINISH POWDER COATING WITH 70-100 MICRON LAYER.
- DUST RESISTANT NEWLY DESIGNED FULL PANEL DB FOR LUXURY INTERIOR.
- HEAVY QUALITY BRASS PARTS & BUSBAR STRIP.

# TRIPRITE

RANGE

## CHOOSE SAFE, CHOOSE RIGHT CHOOSE TRIPRITE

We at PM CONA have safety of our users as our first priority. We manufacture the Best Quality of MCB Range. This range is equipped with high making and breaking capacity. They are 100% safe with short circuit and overload protection and provide great ease in installation. Along with safety, this range has attractive designs and smooth finish. The RCCB has the ability to protect us from fatal shock and also its life is above 2000 operations.

-  Short Circuit & Overload Protection
-  High Heat Resistant Body
-  High Making & Breaking Capacity
-  High Precision Engineering Design
-  Heavy Duty Parts



TripRite DP Isolator 40A



TripRite SP MCB 16A



## Miniature Circuit Breakers "C" Type 240/415 V Ac 50 Hz Supply (Breaking Capacity 10 kA)

SP						SPN					DP				
	CODE	RATE PER Pc. ₹	BOX PKG.	MINI PKG.	BULK PKG.	CODE	RATE PER Pc. ₹	BOX PKG.	MINI PKG.	BULK PKG.	CODE	RATE PER Pc. ₹	BOX PKG.	MINI PKG.	BULK PKG.
<b>6A</b>	3106	<b>205/-</b>	12	60	300	3506	<b>535/-</b>	6	30	150	3206	<b>555/-</b>	6	30	150
<b>10A</b>	3110	<b>205/-</b>	12	60	300	3510	<b>535/-</b>	6	30	150	3210	<b>555/-</b>	6	30	150
<b>16A</b>	3116	<b>205/-</b>	12	60	300	3516	<b>535/-</b>	6	30	150	3216	<b>555/-</b>	6	30	150
<b>20A</b>	3120	<b>205/-</b>	12	60	300	3520	<b>535/-</b>	6	30	150	3220	<b>555/-</b>	6	30	150
<b>25A</b>	3125	<b>205/-</b>	12	60	300	3525	<b>535/-</b>	6	30	150	3225	<b>555/-</b>	6	30	150
<b>32A</b>	3132	<b>205/-</b>	12	60	300	3532	<b>535/-</b>	6	30	150	3232	<b>555/-</b>	6	30	150
<b>40A</b>	3140	<b>325/-</b>	12	60	300	3540	<b>705/-</b>	6	30	150	3240	<b>755/-</b>	6	30	150
<b>63A</b>	3163	<b>395/-</b>	12	60	300	3563	<b>765/-</b>	6	30	150	3263	<b>865/-</b>	6	30	150

TP						TPN					FP				
	CODE	RATE PER Pc. ₹	BOX PKG.	MINI PKG.	BULK PKG.	CODE	RATE PER Pc. ₹	BOX PKG.	MINI PKG.	BULK PKG.	CODE	RATE PER Pc. ₹	BOX PKG.	MINI PKG.	BULK PKG.
<b>6A</b>	3306	<b>865/-</b>	4	20	100	3606	<b>1115/-</b>	3	15	75	3406	<b>1245/-</b>	3	15	75
<b>10A</b>	3310	<b>865/-</b>	4	20	100	3610	<b>1115/-</b>	3	15	75	3410	<b>1245/-</b>	3	15	75
<b>16A</b>	3316	<b>865/-</b>	4	20	100	3616	<b>1115/-</b>	3	15	75	3416	<b>1245/-</b>	3	15	75
<b>20A</b>	3320	<b>865/-</b>	4	20	100	3620	<b>1115/-</b>	3	15	75	3420	<b>1245/-</b>	3	15	75
<b>25A</b>	3325	<b>865/-</b>	4	20	100	3625	<b>1115/-</b>	3	15	75	3425	<b>1245/-</b>	3	15	75
<b>32A</b>	3332	<b>865/-</b>	4	20	100	3632	<b>1115/-</b>	3	15	75	3432	<b>1245/-</b>	3	15	75
<b>40A</b>	3340	<b>1175/-</b>	4	20	100	3640	<b>1415/-</b>	3	15	75	3440	<b>1625/-</b>	3	15	75
<b>63A</b>	3363	<b>1325/-</b>	4	20	100	3663	<b>1675/-</b>	3	15	75	3463	<b>1825/-</b>	3	15	75



## Isolator

DP						FP				
	CODE	RATE PER Pc. ₹	BOX PKG.	MINI PKG.	BULK PKG.	CODE	RATE PER Pc. ₹	BOX PKG.	MINI PKG.	BULK PKG.
<b>40A</b>	4240	<b>385/-</b>	6	30	150	4440	<b>825/-</b>	03	15	75
<b>63A</b>	4263	<b>485/-</b>	6	30	150	4463	<b>965/-</b>	03	15	75



## Residual Current Circuit Breakers 240/415 V Ac 50 Hz Supply

DP							FP								
	30 mA			100 mA			30 mA			100 mA					
	CODE	RATE PER Pc. ₹	BOX PKG.	MINI PKG.	BULK PKG.	CODE	RATE PER Pc. ₹	BOX PKG.	MINI PKG.	BULK PKG.	CODE	RATE PER Pc. ₹	BOX PKG.	MINI PKG.	BULK PKG.
<b>25A</b>	5225	<b>1795/-</b>	-	-	-	-	-	-	-	-	-	-	-	-	-
<b>40A</b>	5240	<b>1795/-</b>	5340	<b>1795/-</b>	6	30	90	5440	<b>2995/-</b>	5640	<b>3095/-</b>	3	15	45	
<b>63A</b>	5263	<b>2045/-</b>	5363	<b>2045/-</b>	6	30	90	5463	<b>3295/-</b>	-	-	-	-	-	



**Changeover** 240/415 V Ac 50 Hz Supply

DP						FP				
	CODE	RATE PER Pc. ₹	BOX PKG.	MINI PKG.	BULK PKG.	CODE	RATE PER Pc. ₹	BOX PKG.	MINI PKG.	BULK PKG.
<b>25A</b>	4625	<b>735/-</b>	6	30	150	-	-	-	-	-
<b>40A</b>	4640	<b>895/-</b>	6	30	150	4740	<b>1895/-</b>	3	15	75
<b>63A</b>	4663	<b>1295/-</b>	6	30	150	4763	<b>2295/-</b>	3	15	75

**PM CONA** Change-over MCBs are mounted on Din-Channel & should be fitted in Distribution Board along with MCBs thus saving space and cost of fitting.



## Distribution Boards (Sheet Enclosures)

With Busbar, Neutral Link And Channel Without MCB

POWER DB'S					
	CODE	RATE PER Pc. ₹	BOX PKG.	MINI PKG.	BULK PKG.
<b>4 Way</b>	3904	<b>1075/-</b>	1	-	20
<b>6 Way</b>	3906	<b>1275/-</b>	1	-	18
<b>8 Way</b>	3908	<b>1375/-</b>	1	-	16
<b>10 Way</b>	3910	<b>1595/-</b>	1	-	14
<b>12 Way</b>	3912	<b>1875/-</b>	1	-	12
<b>16 Way</b>	3916	<b>2095/-</b>	1	-	9



Sufficient Space for Easy & Convenient Wiring.

## Distribution Boards (Sheet Enclosures)









With Busbar, Neutral Link And Channel Without MCB

CLEAR DB'S					
	CODE	RATE PER Pc. ₹	BOX PKG.	MINI PKG.	BULK PKG.
<b>2/4 Way</b>	3804	<b>705/-</b>	1	-	28
<b>6/8 Way</b>	3808	<b>875/-</b>	1	-	18
<b>10/12 Way</b>	3812	<b>1075/-</b>	1	-	14
<b>16 Way</b>	3816	<b>1425/-</b>	1	-	10

# TRISAFE+ RANGE

## PROTECTING YOUR FUTURE, POWERING YOUR LIFE.

PM CONA Tri Safe 3 Layer PVC Insulated Wires are manufactured from excellent quality electrolytic grade bright annealed copper conductor bunched together and insulated with special grade PVC compound having high insulation resistance and dielectric strength. It is non-corrosive and has special flame retardant and low smoke emitting properties. Each metre of wire goes through flammability test, ageing test, high voltage spark test to assure there are no weak spots anywhere in the insulation. It is ideal for concealed and conduit wiring. PM CONA cables carry ISI standardization mark and quality certification which assure complete safety, efficiency, reliability and consistency in performance.

-  Flame Retardant
-  High Oxygen Index
-  Low Smoke
-  99.97% Copper Purity
-  Halogen Free
-  Lead Free
-  Anti Rodent
-  100% Length Guarantee
-  Anti Termite



**FR - LSH**  
Flame Retardant Low Smoke & Halogen  
PVC Insulated Wires  
 Triple Layer Insulation

# TRISAFE+ RANGE

## 3 LAYER PROTECTION

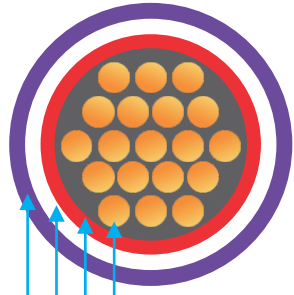

100% Pure Copper  
PVC FR Insulation  
PVC Insulation  
PVC Skin Layer

Sizes mm	Suggested Use
0.75	For Earthing
1.00	Domestic Lighting, Fan, TV, Music System, Small Exhaust fan etc.
1.50	Vacuum Cleaner, Computer & General Purpose
2.50	Oven, Iron, Domestic Water Pump, Washing Machine etc.
4.00	A/c up to 1.50 ton, Geyser, Storage water-heater.
6.00	Main Line, 2.0 To 3.0 Ton A/c etc.

**PM CONA** aims to provide all round safety. PM CONA offers complete electric solutions, our copper wires are made from finest quality raw materials.

Our FR-LSH properties are First Grade Materials, Fire Retardant, Low Smoke & Halogen, Lead Free, Higher Oxygen and Anti Termite which makes them best in its class.

Our wires are suitable for high rise buildings, malls, multiplexes, commercial or residential sectors.

### 20 POINTS

(0.75 to 1.5 sqmm per Coil)

### 50 POINTS

(2.5 to 6 sqmm per Coil)

#### Single Core Non-Sheathed 1100V PVC Insulated Copper Conductor Cable

CODE	NOMINAL AREA OF COPPER CONDUCTOR MM <sup>2</sup>	CLASS OF CONDUCTOR	NOMINAL DIAMETER OF WIRE NO./MM	NOMINAL THICKNESS OF INSULATION MM	MAX OVERALL DIAMETER MM	MAX DC RESISTANCE AT 20°C OHM/KM	CURRENT RATING 2 CABLE SINGLE PHASE AC/DC AMP	RATE PER Coil ₹ MRP (90m)	STD. PKG (90M)
5075	0.75	Class-5	24/0.2	0.6	2.8	26.00	7	<b>2295/-</b>	15
5100	1	Class-5	32/0.2	0.6	3.0	19.50	12	<b>2895/-</b>	15
5150	1.5	Class-5	30/0.25	0.7	3.4	13.30	16	<b>4195/-</b>	10
5250	2.5	Class-5	48/0.25	0.8	4.1	7.98	22	<b>6495/-</b>	10
5400	4	Class-5	56/0.3	0.8	4.8	4.95	29	<b>10995/-</b>	8
5600	6	Class-5	84/0.3	0.8	5.3	3.30	37	<b>16195/-</b>	4

Colours : Red, Yellow, Blue, Black, Green, White.

90m Supplied in box packing

CONNECTING  
YOU TO  
INNOVATION.

# ECO-FR RANGE

## RELIABLE & AFFORDABLE

**100%** Length Guarantee

**99.99%** Copper Purity

**Flame Retardant**

NOMINAL AREA OF COPPER CONDUCTOR MM <sup>2</sup>	CLASS OF CONDUCTOR	NOMINAL DIAMETER OF WIRE NO./MM	NOMINAL THICKNESS OF INSULATION MM	MAX OVERALL DIAMETER MM	MAX DC RESISTANCE AT 20°C OHM/KM	CURRENT RATING 2 CABLE SINGLE PHASE AC/DC AMP
0.75	Class-5	24/0.2	0.6	2.8	26.00	7
1	Class-5	32/0.2	0.6	3.0	19.50	12
1.5	Class-5	30/0.25	0.7	3.4	13.30	16
2.5	Class-5	48/0.25	0.8	4.1	7.98	22
4	Class-5	56/0.3	0.8	4.8	4.95	29
6	Class-5	84/0.3	0.8	5.3	3.30	37

Colours : Red, Yellow, Blue, Black, Green, White.



**20 POINTS**  
(0.75 to 1.5 sqmm per Coil)  
Only on 90MTR Coil

**50 POINTS**  
(2.5 to 6 sqmm per Coil)  
Only on 90MTR Coil

\*Not Applicable on 180 MTR. Length

CODE	SIZE	LENGTH	RATE PER Coil ₹ MRP (90m / 180m)	STD. PKG
7075	0.75 sq. mm	90 MTR	<b>2195/-</b>	15
7100	1 sq. mm	90 MTR	<b>2845/-</b>	15
7150	1.50 sq. mm	90 MTR	<b>4095/-</b>	10
7250	2.50 sq. mm	90 MTR	<b>6395/-</b>	10
7400	4 sq. mm	90 MTR	<b>10595/-</b>	8
7600	6 sq. mm	90 MTR	<b>15595/-</b>	4

6075	0.75 sq. mm	180 MTR	<b>4195/-</b>	As per Order
6100	1 sq. mm	180 MTR	<b>5395/-</b>	As per Order
6150	1.50 sq. mm	180 MTR	<b>7795/-</b>	As per Order
6250	2.50 sq. mm	180 MTR	<b>12195/-</b>	As per Order
6400	4 sq. mm	180 MTR	<b>19995/-</b>	As per Order
6600	6 sq. mm	180 MTR	<b>29995/-</b>	As per Order

Colours : Red, Yellow, Blue, Black, Green, White.



Note: Availability of entire ECO FR Wires is on order basis.



### COUPONS APPLICABLE FROM APRIL 2026

<b>STATUS RANGE</b> (White & Grey Accessories)	Status 6A 3pin Socket	2 Points (Per Piece)
	Status 16A Socket	2 Points (Per Piece)
	Status Mini Dimmer	5 Points (Per Piece)
	Status 4 Step Regulator	5 Points (Per Piece)
	Status 5 Step Regulator	5 Points (Per Piece)
	All Axis Plates (1M to 18M)	5 Points (Per Piece)
	All Edge Plates (1M to 6M)	5 Points (Per Piece)
	All Edge Plates (8M to 18M)	10 Points (Per Piece)

<b>ESTELLA RANGE</b> (White & Grey Accessories)	Estella 10AX 1 Way Switch	2 Points (Per Piece)
	Estella 20A 1 Way Switch	2 Points (Per Piece)
	Estella 6A 3 Pin Socket	2 Points (Per Piece)
	Estella 16A Socket	2 Points (Per Piece)
	Estella 4 Step Regulator	5 Points (Per Piece)
	Estella 5 Step Regulator	5 Points (Per Piece)
	All Estella, Marvel & Posh Plates (1M to 6M) <small>*Not Applicable on Only Base Plates</small>	5 Points (Per Piece)
	All Estella, Marvel & Posh Plates (8M to 18M) <small>*Not Applicable on Only Base Plates</small>	10 Points (Per Piece)

<b>PLATINUM RANGE</b>	All Platinum Range 10A 1way Switch	2 Points (Per Piece)
	All Platinum Range 20A 1way Switch	2 Points (Per Piece)
	Platinum 6A 3pin Socket	2 Points (Per Piece)
	Platinum 16A Socket	2 Points (Per Piece)
	Platinum 4 Step Regulator	5 Points (Per Piece)
	Platinum 5 Step Regulator	5 Points (Per Piece)
	All Platinum Plates (1M to 6M)	5 Points (Per Piece)
	All Platinum Plates (8M to 18M)	10 Points (Per Piece)

<b>TRISAFE+ RANGE</b> 90 Mtr	0.75 sqmm, 1 sqmm, 1.5 sqmm	20 Points (Per Coil)
	2.5 sqmm, 4 sqmm, 6 sqmm	50 Points (Per Coil)

<b>ECO-FR RANGE</b> 90 Mtr	0.75 sqmm, 1 sqmm, 1.5 sqmm	20 Points (Per Coil)
	2.5 sqmm, 4 sqmm, 6 sqmm	50 Points (Per Coil)

<b>ASSURE RANGE</b>	Assure SP MCB	10 Points (Per Piece)
	Assure Multi Pole MCB, Isolator, Changeover	20 Points (Per Piece)
	Assure RCCB, ACCL, MCCB	20 Points (Per Piece)

## Scan & Redemption Info



Purchase Eligible PM CONA Products Which Has Coupons.

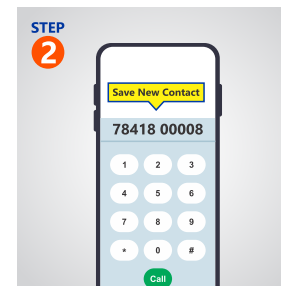

Save Contact as PM CONA Powerman or PM CONA Money



Scratch The Coupon Given On Left Side

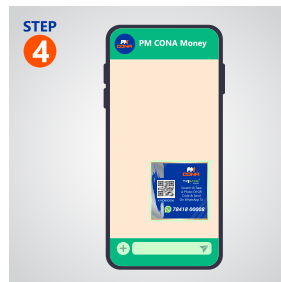

Send A Clear Photo Of The Coupon On The Whatsapp Number 78418 00008.

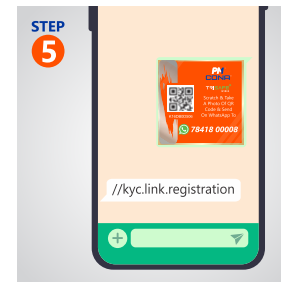

You Will Get One Time Link To Register Your Mobile Number/ Complete KYC (Kindly Fill The Details In The Link).

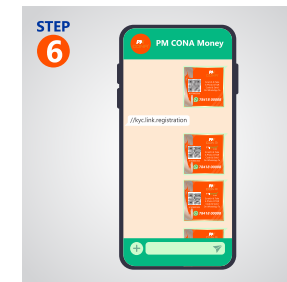

Once Your Number Is Registered Then You Have To Just Scratch The Coupon & Send Clear Photo Of All Future Coupons.

## Collect Reward

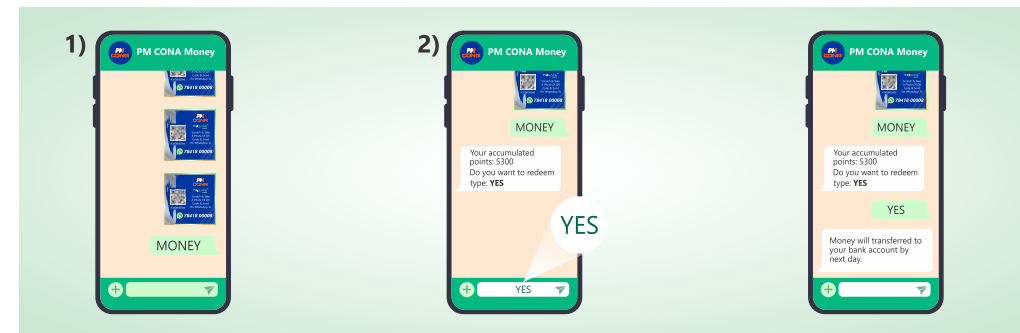

1 - You can type **MONEY** and send it to Whatsapp number **7841800008**.  
2 -Type **YES** when asked for confirmation. Money will transferred to your bank account by next day.

# SKYLIGHT RANGE

PM<sup>®</sup>  
CONA<sup>®</sup>



CONNECTING YOU TO  
INNOVATION

---

**PM**<sup>®</sup>  
**CONA**<sup>®</sup>

PRODUCT RANGE



**STATUS**  
RANGE

The Status Range is a standard modular range with various improvisations and is preferred by many. It is robust with a sleek and elegant design. The plates of this range are Axis, Smartwood, Solo and Smile. These plates come with blue-coloured LED Indicator which can be connected to the switch as an indicator or directly connected to the main supply, so that it can be located in the dark yet ensures soft light so as not disturbing to the eyes. This feature was First of its kind in India.



## **ESTELLA** RANGE

**"TO IMPROVE IS TO CHANGE, TO BE PERFECT IS TO CHANGE OFTEN."**  
WINSTON CHURCHILL

At **PM CONA** we have always welcomed change with open arms and curious eyes, which has helped us to mark our position in the market from last **55 years**.

To continue the same passion for perfection we have created our most Dynamic and Modern looking Modular Range.

**ESTELLA** which means **E- extraordinary STELLA- star**, Need we say more.....!!



## **PLATINUM** RANGE

Platinum Range is a modular range with SofTouch technology for smooth operation of switches. All frame plates have chrome finished rings for rich look. Soft light blue led indicator in switches and frame plates. Simple yet strong locking of top bottom of frame plate. Products like glass look plates, new variety of switches etc.. It's Regulators (4 Step and 5 Step) with blue led indicator, Unique designs of all accessories.



## VALUE RANGE

We have a wide range of supporting products created with attractive and innovative designs. We offer a wide variety of designs and colors to choose from for even a simple device as the Extension Box. The bells and chimes have melodious and light tunes making the environment light and joyful. These are high in quality and very durable making it largely preferable and useful.



## GOLD RANGE

The PM CONA Gold Range is a popular one with a high usage figure. The products in this range have outlasted most of the products across the industry. It has been the most consistent and evergreen product in the trade. They are manufactured using Formaldehyde. The products are high in quality owing to the usage of heavy brass, good quality powder and most importantly very fine craftsmanship making many customers loyal to this range. Available in two colours - Off White & Milky White.



## WAWA RANGE

Launched a few years back, the Wawa Range has been appreciated and utilized owing to its pricing, superior quality heavy brass parts, extremely attractive design and smooth finish. This range is available in Snow White colour which enhances its design quality and flawless finish.







## List of PM CONA Branches based throughout INDIA

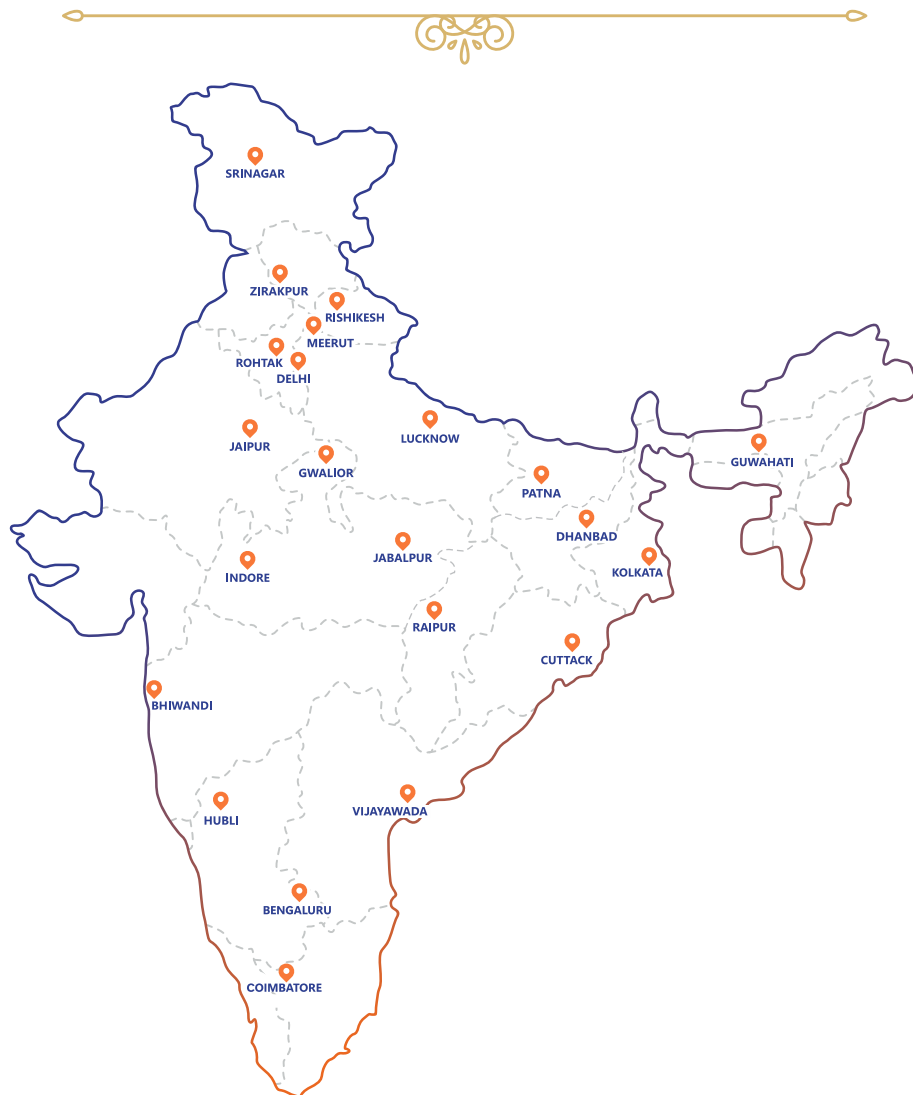

## LIST OF AWARDS RECEIVED BY PM CONA

- FAST 50- CONSUMERS & INDUSTRY FASTEST GROWING BRAND 2016
  - ASIA ONE- INDIA'S GREATEST LEADER
  - ASIA ONE- INDIA'S GREATEST BRAND
  - ESTRADE BUILT AWARD, SINGAPORE
    - POWER LEADER (WCRC)
- PRIDE OF INDIA INTERNATIONAL AWARD, KHATMANDU (NEPAL)
  - RASHTRIYA UDHYOG PRATIBHA AWARD, PANJIM (GOA)
    - EXTRA ORDINAIRE BRAND
      - INEX -INTERIOR & EXTERIOR AWARDS 2018-
  - ELECARAMA AWARD FOR BEST STALL 2012, MUMBAI
  - VIJAY RATTAN GOLD MEDAL AWARD, NEW DELHI
  - RAJIV GANDHI EXCELLENCE AWARD, NEW DELHI
    - STAR OF ASIA AWARD (IBC), NEW DELHI
    - INDIRA GANDHI PRIYADARSHINI AWARD
- INTERNATIONAL GOLD STAR MILLENIUM AWARD, BANGKOK (THAILAND)
  - GOLDEN CITIZEN OF INDIA AWARD, NEW DELHI
  - BHARAT VIBHUSHAN SAMMAN PURASKAR, DEHRADUN
    - BHARTIYA UDHYOG RATAN AWARD, NEW DELHI
      - ASIA PACIFIC ACHEIVER AWARD, DUBAI
  - INTERNATIONAL INDUSTRIAL EXCELLENCE AWARD, DUBAI
    - INDIRA GANDHI SADBHAVANA AWARD, NEW DELHI
- DR. OF HUMANITY AWARD (INDUSTRY & SOCIAL WELFARE), CHENNAI
  - BUSINESS EXCELLENCE AWARD, BANGALORE
    - INDUSTRIAL EXCELLENCE AWARD, GOA
  - ASIA PACIFIC GOLD STAR AWARD, UZBEKISTAN
  - MOTHER TERESA SADBHAWANA AWARD, DELHI
  - BRAND OF THE YEAR (CEO MAGAZINE), NEW DELHI
- PATNA ELECTRIC TRADER ASSOCIATION -BEST STALL AWARD, PATNA
  - ASIA PACIFIC INTERNATIONAL AWARD, BANGKOK (THAILAND)
  - RASHTRIYA VIKAS SHIROMANI AWARD, DEHRADUN
  - DR. A.P.J KALAM LIFETIME ACHIEVEMENT AWARD, CHENNAI
- ARCH OF INTERNATIONAL EXCELLENCE AWARD, BANGKOK (THAILAND)
  - THE NATIONAL INSTITUTE FOR ENTERPRENUERSHIP AND SMALL BUSINESS DEVELOPMENT (FOR PARTICIPATION), MUMBAI
    - BIHAR ELECTRIC TRADERS ASSOCIATION, BIHAR
      - VIDYUT VYAPAR MELA, GHAZIABAD